

# SKiiP 39AC12T4V10

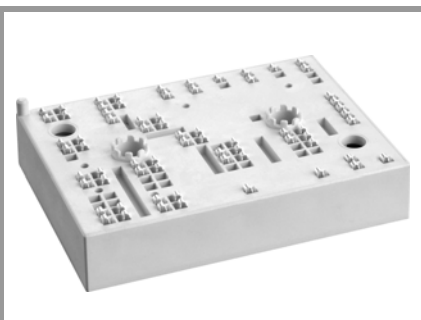

MiniSKiiP® 3

## SKiiP 39AC12T4V10

### Features

- Trench 4 IGBTs
- Robust and soft freewheeling diodes in CAL technology
- Highly reliable spring contacts for electrical connections
- UL recognised: File no. E63532

### Typical Applications\*

- Inverter up to 50 kVA
- Typical motor power 30 kW

### Remarks

- Max. case temperature limited to  $T_C=125^\circ\text{C}$
- Product reliability results valid for  $T_j \leq 150^\circ\text{C}$  (recommended  $T_{j,op} = -40 \dots +150^\circ\text{C}$ )
- For short circuit: Soft  $R_{Goff}$  recommended
- MiniSKiiP "Technical Explanations" and "Mounting Instructions" are part of the data sheet. Please refer to both documents for further information.

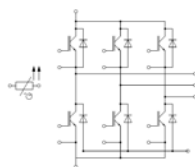

AC

Absolute Maximum Ratings				
Symbol	Conditions		Values	Unit
<b>Inverter - IGBT</b>				
$V_{CES}$	$T_j = 25^\circ\text{C}$		1200	V
$I_C$	$\lambda_{paste}=0.8 \text{ W/(mK)}$	$T_s = 25^\circ\text{C}$	167	A
		$T_j = 175^\circ\text{C}$	135	A
$I_C$	$\lambda_{paste}=2.5 \text{ W/(mK)}$	$T_s = 25^\circ\text{C}$	217	A
		$T_j = 175^\circ\text{C}$	177	A
$I_{Cnom}$			150	A
$I_{CRM}$	$I_{CRM} = 3 \times I_{Cnom}$		450	A
$V_{GES}$			-20 ... 20	V
$t_{psc}$	$V_{CC} = 800 \text{ V}$	$T_j = 150^\circ\text{C}$	10	$\mu\text{s}$
	$V_{GE} \leq 15 \text{ V}$			
	$V_{CES} \leq 1200 \text{ V}$			
$T_j$			-40 ... 175	$^\circ\text{C}$
<b>Inverse - Diode</b>				
$I_F$	$\lambda_{paste}=0.8 \text{ W/(mK)}$	$T_s = 25^\circ\text{C}$	136	A
		$T_j = 175^\circ\text{C}$	107	A
$I_F$	$\lambda_{paste}=2.5 \text{ W/(mK)}$	$T_s = 25^\circ\text{C}$	163	A
		$T_j = 175^\circ\text{C}$	130	A
$I_{Fnom}$			150	A
$I_{FRM}$	$I_{FRM} = 3 \times I_{Fnom}$		450	A
$I_{FSM}$	10 ms, sin 180°, $T_j = 150^\circ\text{C}$		900	A
$T_j$			-40 ... 175	$^\circ\text{C}$
<b>Module</b>				
$I_t(\text{RMS})$	$T_{terminal} = 80^\circ\text{C}$ , 20 A per spring		160	A
$T_{stg}$			-40 ... 125	$^\circ\text{C}$
$V_{isol}$	AC sinus 50 Hz, $t = 1 \text{ min}$		2500	V

Characteristics						
Symbol	Conditions		min.	typ.	max.	Unit
<b>Inverter - IGBT</b>						
$V_{CE(sat)}$	$I_C = 150 \text{ A}$ $V_{GE} = 15 \text{ V}$ chipelevel	$T_j = 25^\circ\text{C}$	1.85	2.10		V
		$T_j = 150^\circ\text{C}$	2.25	2.45		V
$V_{CE0}$	chipelevel	$T_j = 25^\circ\text{C}$	0.80	0.90		V
		$T_j = 150^\circ\text{C}$	0.70	0.80		V
$r_{CE}$	$V_{GE} = 15 \text{ V}$ chipelevel	$T_j = 25^\circ\text{C}$	7.0	8.0		m $\Omega$
		$T_j = 150^\circ\text{C}$	10	11		m $\Omega$
$V_{GE(th)}$	$V_{GE} = V_{CE}$ , $I_C = 6 \text{ mA}$		5	5.8	6.5	V
$I_{CES}$	$V_{GE} = 0 \text{ V}$ , $V_{CE} = 1200 \text{ V}$ , $T_j = 25^\circ\text{C}$		0.1	0.3		mA
$C_{ies}$	$V_{CE} = 25 \text{ V}$ $V_{GE} = 0 \text{ V}$	$f = 1 \text{ MHz}$	8.80			nF
$C_{oes}$		$f = 1 \text{ MHz}$	0.58			nF
$C_{res}$		$f = 1 \text{ MHz}$	0.47			nF
$Q_G$	- 8 V...+ 15 V			850		nC
$R_{Gint}$	$T_j = 25^\circ\text{C}$			5.0		$\Omega$
$t_{d(on)}$	$V_{CC} = 600 \text{ V}$	$T_j = 150^\circ\text{C}$		165		ns
$t_r$	$I_C = 150 \text{ A}$ $R_{Gon} = 1 \Omega$	$T_j = 150^\circ\text{C}$		50		ns
		$T_j = 150^\circ\text{C}$		22.5		mJ
$E_{on}$	$R_{Goff} = 1 \Omega$	$T_j = 150^\circ\text{C}$		22.5		mJ
$t_{d(off)}$	$di/dt_{on} = 2840 \text{ A}/\mu\text{s}$	$T_j = 150^\circ\text{C}$		390		ns
$t_f$	$di/dt_{off} = 1880 \text{ A}/\mu\text{s}$	$T_j = 150^\circ\text{C}$		80		ns
$E_{off}$	$V_{GE} = +15/-15 \text{ V}$	$T_j = 150^\circ\text{C}$		14		mJ
$R_{th(j-s)}$	per IGBT, $\lambda_{paste}=0.8 \text{ W/(mK)}$			0.33		K/W
$R_{th(j-s)}$	per IGBT, $\lambda_{paste}=2.5 \text{ W/(mK)}$			0.21		K/W

# SKiiP 39AC12T4V10

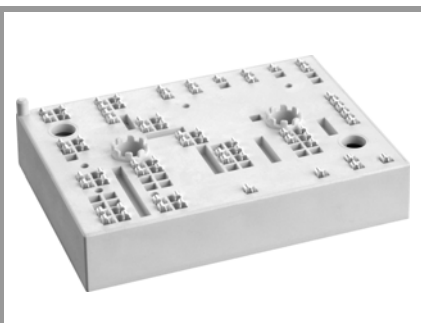

MiniSKiiP® 3

## SKiiP 39AC12T4V10

### Features

- Trench 4 IGBTs
- Robust and soft freewheeling diodes in CAL technology
- Highly reliable spring contacts for electrical connections
- UL recognised: File no. E63532

### Typical Applications\*

- Inverter up to 50 kVA
- Typical motor power 30 kW

### Remarks

- Max. case temperature limited to  $T_C=125^{\circ}\text{C}$
- Product reliability results valid for  $T_j \leq 150^{\circ}\text{C}$  (recommended  $T_{j,op} = -40 \dots +150^{\circ}\text{C}$ )
- For short circuit: Soft  $R_{Goff}$  recommended
- MiniSKiiP "Technical Explanations" and "Mounting Instructions" are part of the data sheet. Please refer to both documents for further information.

Characteristics						
Symbol	Conditions		min.	typ.	max.	Unit
<b>Inverse - Diode</b>						
$V_F = V_{EC}$	$I_F = 150\text{ A}$ $V_{GE} = 0\text{ V}$ chipelevel	$T_j = 25^{\circ}\text{C}$		2.14	2.46	V
		$T_j = 150^{\circ}\text{C}$		2.07	2.38	V
$V_{F0}$	chipelevel	$T_j = 25^{\circ}\text{C}$		1.30	1.50	V
		$T_j = 150^{\circ}\text{C}$		0.90	1.10	V
$r_F$	chipelevel	$T_j = 25^{\circ}\text{C}$		5.6	6.4	m $\Omega$
		$T_j = 150^{\circ}\text{C}$		7.8	8.5	m $\Omega$
$I_{RRM}$	$I_F = 150\text{ A}$	$T_j = 150^{\circ}\text{C}$		188		A
$Q_{rr}$	$di/dt_{off} = 4020\text{ A}/\mu\text{s}$ +15/-15	$T_j = 150^{\circ}\text{C}$		27		$\mu\text{C}$
$E_{rr}$	$V_{CC} = 600\text{ V}$	$T_j = 150^{\circ}\text{C}$		11.4		mJ
$R_{th(j-s)}$	per Diode, $\lambda_{paste}=0.8\text{ W}/(\text{mK})$			0.52		K/W
$R_{th(j-s)}$	per Diode, $\lambda_{paste}=2.5\text{ W}/(\text{mK})$			0.39		K/W
<b>Module</b>						
$L_{CE}$						nH
$M_s$	to heat sink		2		2.5	Nm
$W$				82		g
<b>Temperature Sensor</b>						
$R_{100}$	$T_r=100^{\circ}\text{C}$ ( $R_{25}=1000\Omega$ )			1670 $\pm$ 3%		$\Omega$
$R(T)$	$R(T)=1000\Omega[1+A(T-25^{\circ}\text{C})+B(T-25^{\circ}\text{C})^2]$ ], $A = 7.635 \cdot 10^{-3} \text{ }^{\circ}\text{C}^{-1}$ , $B = 1.731 \cdot 10^{-5} \text{ }^{\circ}\text{C}^{-2}$					

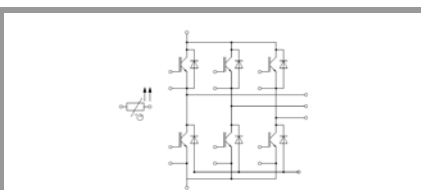

AC

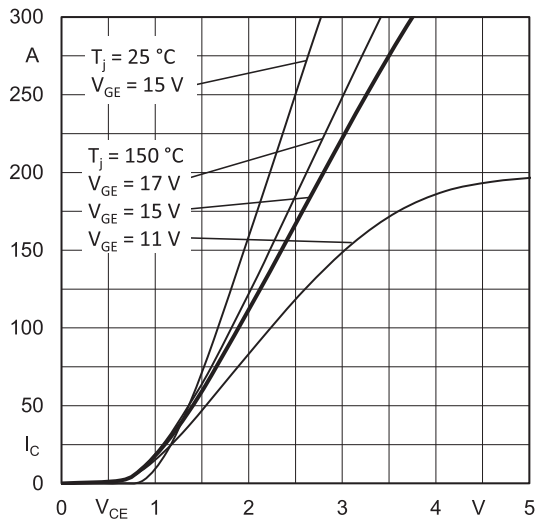

Fig. 1: Typ. output characteristic, inclusive  $R_{CC+EE}$

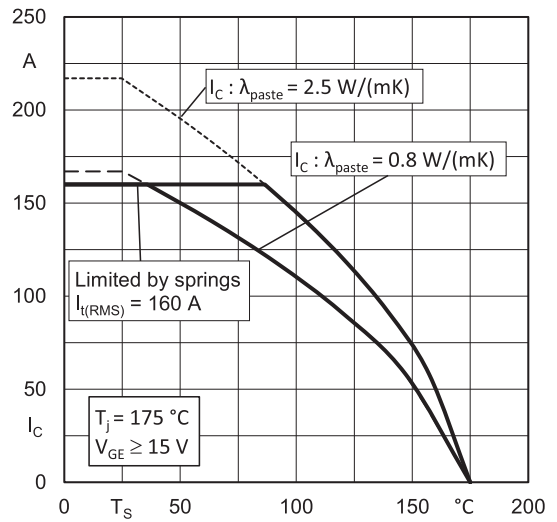

Fig. 2: Rated current vs. temperature  $I_C = f(T_S)$

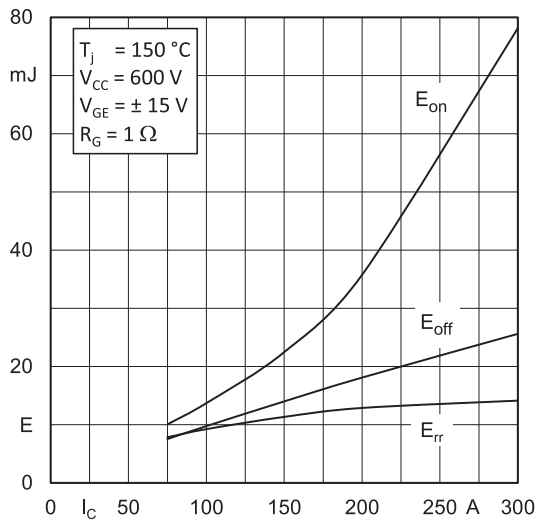

Fig. 3: Typ. turn-on /-off energy =  $f(I_C)$

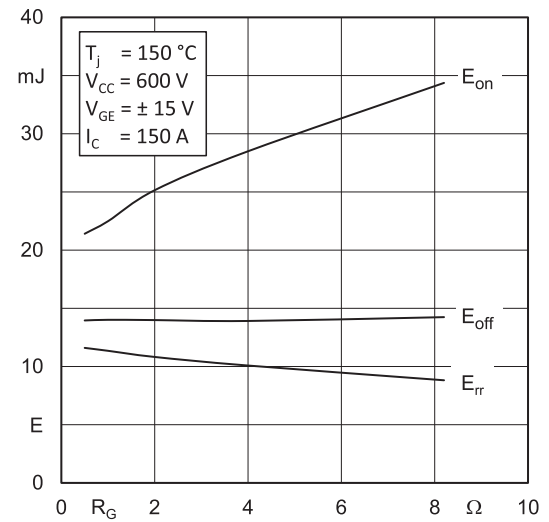

Fig. 4: Typ. turn-on /-off energy =  $f(R_G)$

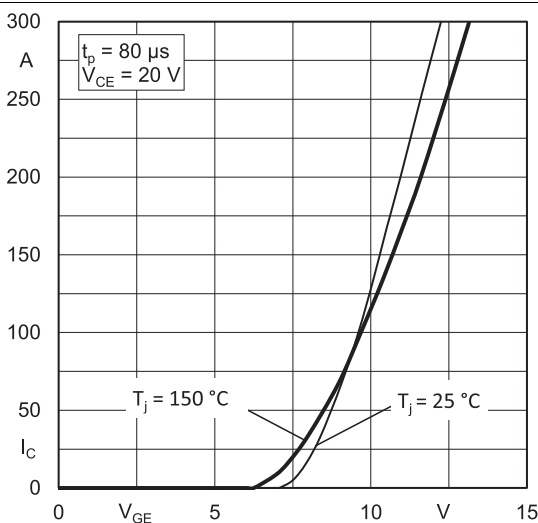

Fig. 5: Typ. transfer characteristic

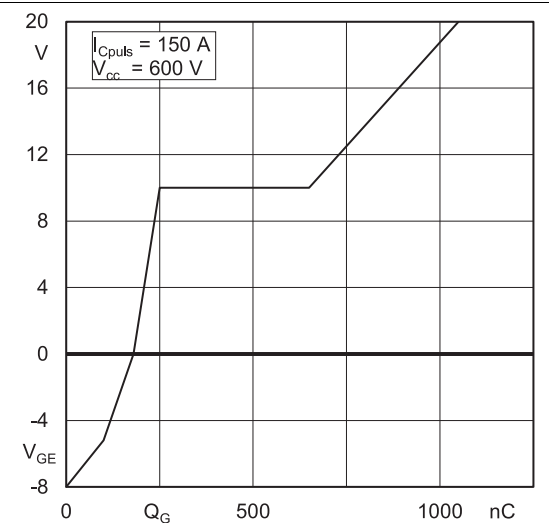
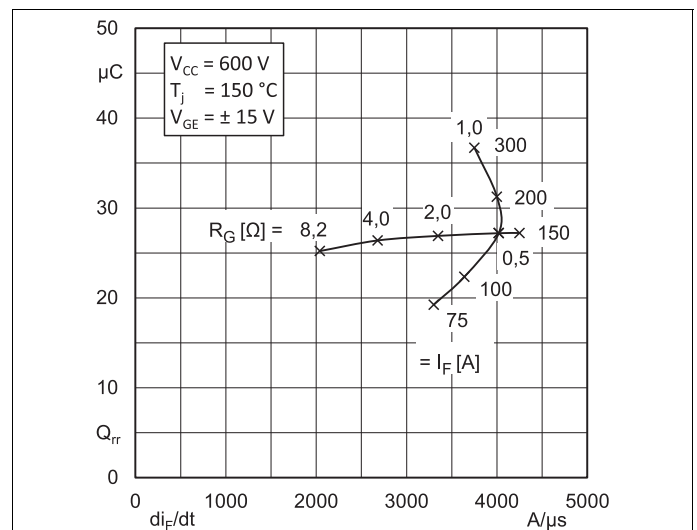
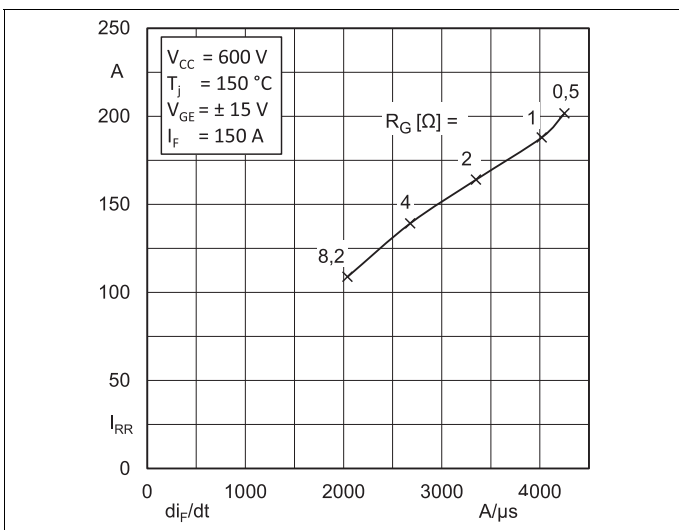
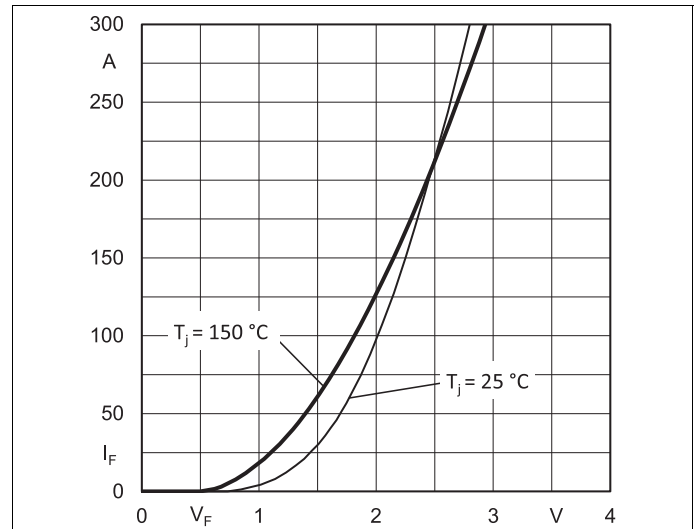
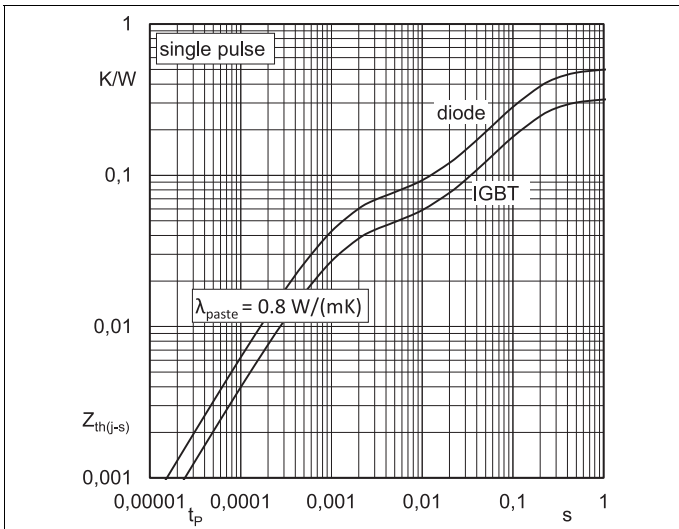
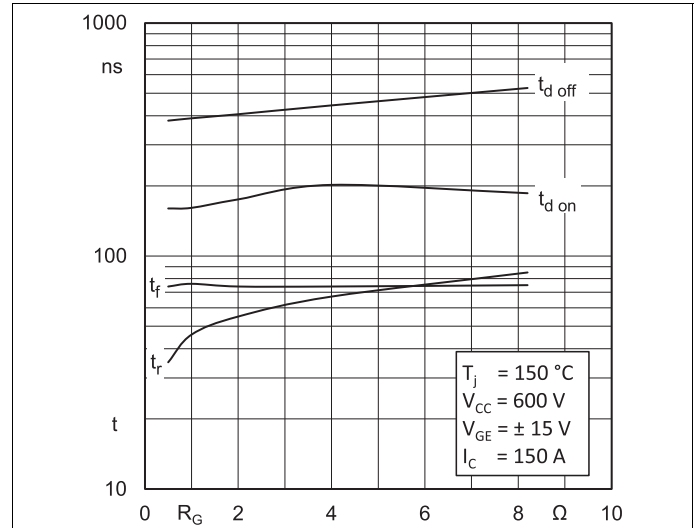
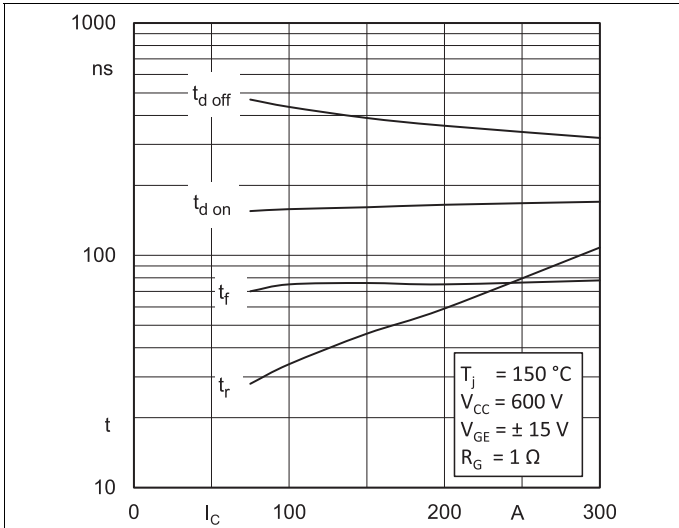
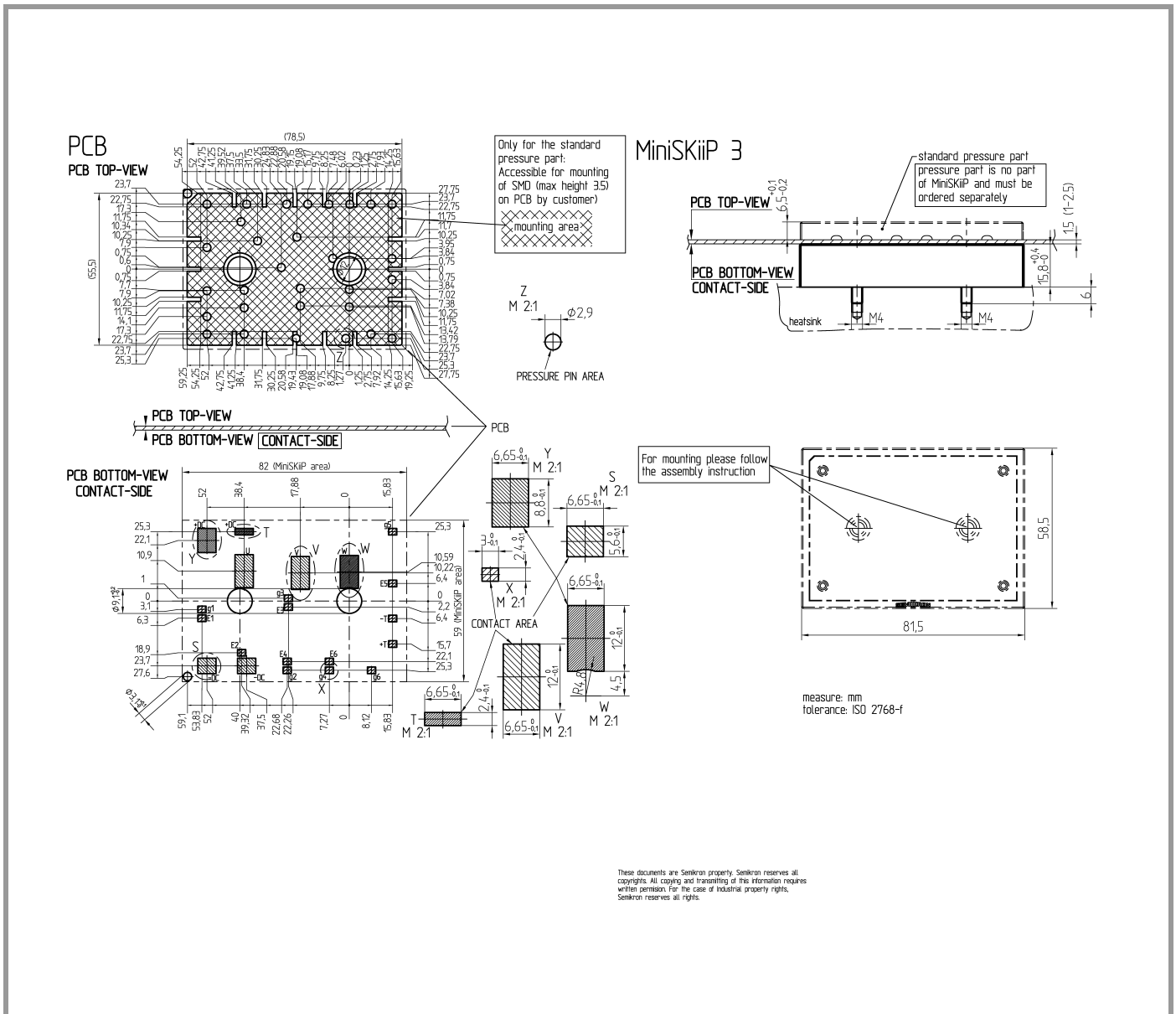
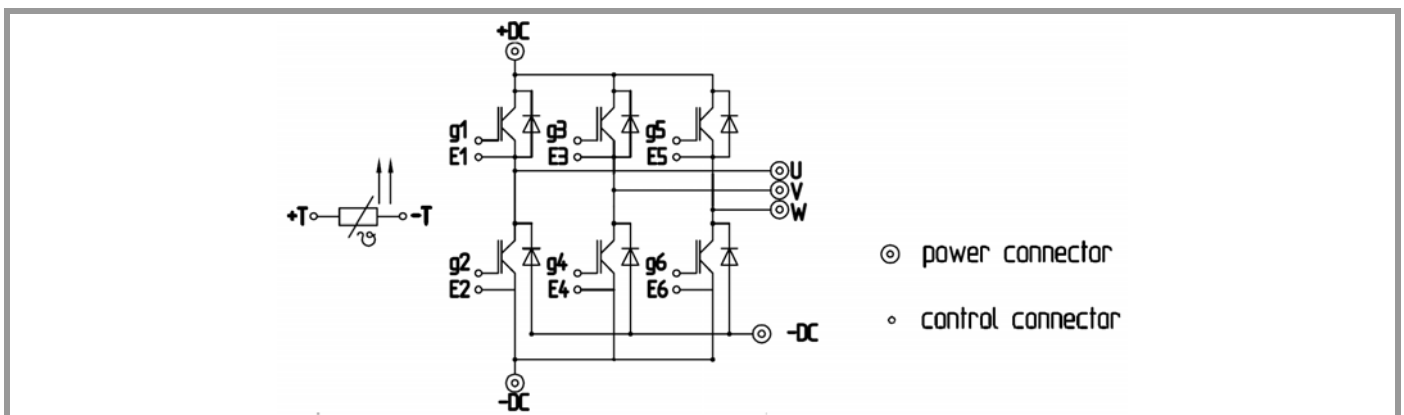

Fig. 6: Typ. gate charge characteristic





pinout, dimensions



pinout

This is an electrostatic discharge sensitive device (ESDS), international standard IEC 60747-1, chapter IX.

**\*IMPORTANT INFORMATION AND WARNINGS**

The specifications of SEMIKRON products may not be considered as guarantee or assurance of product characteristics ("Beschaffenheitsgarantie"). The specifications of SEMIKRON products describe only the usual characteristics of products to be expected in

typical applications, which may still vary depending on the specific application. Therefore, products must be tested for the respective application in advance. Application adjustments may be necessary. The user of SEMIKRON products is responsible for the safety of their applications embedding SEMIKRON products and must take adequate safety measures to prevent the applications from causing a physical injury, fire or other problem if any of SEMIKRON products become faulty. The user is responsible to make sure that the application design is compliant with all applicable laws, regulations, norms and standards. Except as otherwise explicitly approved by SEMIKRON in a written document signed by authorized representatives of SEMIKRON, SEMIKRON products may not be used in any applications where a failure of the product or any consequences of the use thereof can reasonably be expected to result in personal injury. No representation or warranty is given and no liability is assumed with respect to the accuracy, completeness and/or use of any information herein, including without limitation, warranties of non-infringement of intellectual property rights of any third party. SEMIKRON does not assume any liability arising out of the applications or use of any product; neither does it convey any license under its patent rights, copyrights, trade secrets or other intellectual property rights, nor the rights of others. SEMIKRON makes no representation or warranty of non-infringement or alleged non-infringement of intellectual property rights of any third party which may arise from applications. Due to technical requirements our products may contain dangerous substances. For information on the types in question please contact the nearest SEMIKRON sales office. This document supersedes and replaces all information previously supplied and may be superseded by updates. SEMIKRON reserves the right to make changes.