

Phase Control Thyristor

Types N3533Z#140 to N3533Z#220

Old Type No.: N1400CH02-20

Absolute Maximum Ratings

	VOLTAGE RATINGS	MAXIMUM LIMITS	UNITS
V_{DRM}	Repetitive peak off-state voltage, (note 1)	1400-2200	V
V_{DSM}	Non-repetitive peak off-state voltage, (note 1)	1400-2200	V
V_{RRM}	Repetitive peak reverse voltage, (note 1)	1400-2200	V
V_{RSM}	Non-repetitive peak reverse voltage, (note 1)	1500-2300	V

	OTHER RATINGS	MAXIMUM LIMITS	UNITS
$I_{T(AV)}$	Mean on-state current. $T_{sink}=55^{\circ}C$, (note 2)	3533	A
$I_{T(AV)}$	Mean on-state current. $T_{sink}=85^{\circ}C$, (note 2)	2377	A
$I_{T(AV)}$	Mean on-state current. $T_{sink}=85^{\circ}C$, (note 3)	1398	A
$I_{T(RMS)}$	Nominal RMS on-state current. $T_{sink}=25^{\circ}C$, (note 2)	7052	A
$I_{T(d.c.)}$	D.C. on-state current. $T_{sink}=25^{\circ}C$, (note 4)	5929	A
I_{TSM}	Peak non-repetitive surge $t_p=10ms$, $V_{rm}=0.6V_{RRM}$, (note 5)	50	kA
I_{TSM2}	Peak non-repetitive surge $t_p=10ms$, $V_{rm}\leq 10V$, (note 5)	60	kA
I^2t	I^2t capacity for fusing $t_p=10ms$, $V_{rm}=0.6V_{RRM}$, (note 5)	12.5×10^6	A^2s
I^2t	I^2t capacity for fusing $t_p=10ms$, $V_{rm}\leq 10V$, (note 5)	18.0×10^6	A^2s
di_T/dt	Maximum rate of rise of on-state current (repetitive), (Note 6)	150	$A/\mu s$
	Maximum rate of rise of on-state current (non-repetitive), (Note 6)	300	$A/\mu s$
V_{RGM}	Peak reverse gate voltage	5	V
$P_{G(AV)}$	Mean forward gate power	5	W
P_{GM}	Peak forward gate power	30	W
V_{GD}	Non-trigger gate voltage, (Note 7)	0.25	V
T_{HS}	Operating temperature range	-40 to +125	$^{\circ}C$
T_{stg}	Storage temperature range	-40 to +150	$^{\circ}C$

Notes: -

- 1) De-rating factor of 0.13% per $^{\circ}C$ is applicable for T_j below $25^{\circ}C$.
- 2) Double side cooled, single phase; 50Hz, 180° half-sinewave.
- 3) Single side cooled, single phase; 50Hz, 180° half-sinewave.
- 4) Double side cooled.
- 5) Half-sinewave, $125^{\circ}C$ T_j initial.
- 6) $V_D=67\% V_{DRM}$, $I_{TM}=1000A$, $I_{FG}=2A$, $t_r\leq 0.5\mu s$, $T_{case}=125^{\circ}C$.
- 7) Rated V_{DRM} .

Characteristics

	PARAMETER	MIN.	TYP.	MAX.	TEST CONDITIONS (Note 1)	UNIT S
V _{TM}	Maximum peak on-state voltage	-	-	1.25	I _{TM} =3000A	V
V _{T0}	Threshold voltage	-	-	0.97		V
r _T	Slope resistance	-	-	0.095		mΩ
dv/dt	Critical rate of rise of off-state voltage	1000	-	-	V _D =80% V _{DRM} , linear ramp, Gate O/C	V/μs
I _{DRM}	Peak off-state current	-	-	200	Rated V _{DRM}	mA
I _{RDM}	Peak reverse current	-	-	200	Rated V _{RRM}	mA
V _{GT}	Gate trigger voltage	-	-	3.0	T _J =25°C, V _D =10V, I _T =3A	V
I _{GT}	Gate trigger current	-	-	300		mA
I _H	Holding current	-	-	1000	T _J =25°C	mA
t _{gd}	Gate controlled turn-on delay time	-	1.0	2.0	V _D =67%V _{DRM} , I _{TM} =2000A, di/dt=10A/μs, I _{FG} =2A, t _r =0.5μs, T _J =25°C	μs
t _{gt}	Turn-on time	-	2.0	3.0		μs
Q _{rr}	Recovered Charge	-	2700	-	I _{TM} =4000A, t _p =1000μs, di/dt=10A/μs, V _r =50V	μC
Q _{ra}	Recovered Charge, 50% chord	-	1700	2300		μC
I _{rm}	Reverse recovery current	-	135	-		A
t _{rr}	Reverse recovery time, 50% chord	-	25	-		μs
t _q	Turn-off time	-	250	-	I _{TM} =4000A, t _p =1000μs, di/dt=10A/μs, V _r =50V, V _{dr} =80%V _{DRM} , dV _{dr} /dt=20V/μs	μs
		-	450	-	I _{TM} =4000A, t _p =1000μs, di/dt=10A/μs, V _r =50V, V _{dr} =80%V _{DRM} , dV _{dr} /dt=200V/μs	
R _{th(j-hs)}	Thermal resistance, junction to heatsink	-	-	0.011	Double side cooled	K/W
		-	-	0.022	Single side cooled	K/W
F	Mounting force	27	-	47		kN
W _t	Weight	-	1.7	-	Outline options ZC & ZT	kg
		-	1.2	-	Outline options ZD & ZV	

Notes: -

- 1) Unless otherwise indicated T_J=125°C.
- 2) For other clamp forces please consult factory.

Notes on rupture rated packages.

This product is available with a non-rupture rated package.

For additional details on these products, please consult factory.

Notes on Ratings and Characteristics

1.0 Voltage Grade Table

Voltage Grade	V_{DRM} V_{DSM} V_{RRM} V	V_{RSM} V	V_D V_R DC V
14	1400	1500	930
16	1600	1700	1040
18	1800	1900	1150
20	2000	2100	1250
22	2200	2300	1350

2.0 Extension of Voltage Grades

This report is applicable to other and higher voltage grades when supply has been agreed by Sales/Production.

3.0 De-rating Factor

A blocking voltage de-rating factor of 0.13%/°C is applicable to this device for T_j below 25°C.

4.0 Repetitive dv/dt

Standard dv/dt is 1000V/μs.

5.0 Rate of rise of on-state current

The maximum un-primed rate of rise of on-state current must not exceed 300A/μs at any time during turn-on on a non-repetitive basis. For repetitive performance, the on-state rate of rise of current must not exceed 150A/μs at any time during turn-on. Note that these values of rate of rise of current apply to the total device current including that from any local snubber network.

6.0 Gate Drive

The recommended pulse gate drive is 30V, 15Ω with a short-circuit current rise time of not more than 0.5μs. This gate drive must be applied when using the full di/dt capability of the device.

The pulse duration may need to be configured according to the application but should be no shorter than 20μs, otherwise an increase in pulse current may be needed to supply the necessary charge to trigger.

7.0 Computer Modelling Parameters

7.1 Device Dissipation Calculations

$$I_{AV} = \frac{-V_{T0} + \sqrt{V_{T0}^2 + 4 \cdot ff^2 \cdot r_T \cdot W_{AV}}}{2 \cdot ff^2 \cdot r_T}$$

and:

$$W_{AV} = \frac{\Delta T}{R_{th}}$$

$$\Delta T = T_{jmax} - T_K$$

Where $V_{T0}=0.97V$, $r_T=0.095m\Omega$,

R_{th} = Supplementary thermal impedance, see table below.

ff = Form factor, see table below.

Supplementary Thermal Impedance

Conduction Angle	30°	60°	90°	120°	180°	270°	d.c.
Square wave Double Side Cooled	0.0124	0.0122	0.0121	0.0119	0.0117	0.0113	0.011
Square wave Single Side Cooled	0.0249	0.0248	0.0247	0.0246	0.0244	0.0241	0.022
Sine wave Double Side Cooled	0.0168	0.0140	0.0131	0.0118	0.0112		
Sine wave Single Side Cooled	0.0249	0.0247	0.0246	0.0244	0.0241		

Form Factors

Conduction Angle	30°	60°	90°	120°	180°	270°	d.c.
Square wave	3.46	2.45	2	1.73	1.41	1.15	1
Sine wave	3.98	2.78	2.22	1.88	1.57		

7.2 Calculating V_T using ABCD Coefficients

The on-state characteristic I_T vs. V_T , on page 5 is represented in two ways;

- (i) the well established V_{T0} and r_T tangent used for rating purposes and
- (ii) a set of constants A, B, C, D, forming the coefficients of the representative equation for V_T in terms of I_T given below:

$$V_T = A + B \cdot \ln(I_T) + C \cdot I_T + D \cdot \sqrt{I_T}$$

The constants, derived by curve fitting software, are given below for both hot and cold characteristics. The resulting values for V_T agree with the true device characteristic over a current range, which is limited to that plotted.

	25°C Coefficients	125°C Coefficients
A	1.172801	0.436704226
B	-0.03717729	0.06350879
C	5.397833×10^{-5}	1.720213×10^{-4}
D	4.65×10^{-3}	-3.856749×10^{-3}

7.3 D.C. Thermal Impedance Calculation

$$r_t = \sum_{p=1}^{p=n} r_p \cdot \left(1 - e^{-\frac{t}{\tau_p}} \right)$$

Where $p = 1$ to n , n is the number of terms in the series and:

- t : Duration of heating pulse in seconds.
- r_t : Thermal resistance at time t .
- r_p : Amplitude of p_{th} term.
- τ_p : Time Constant of r_{th} term.

D.C. Double Side Cooled				
Term	1	2	3	4
r_p	6.72×10^{-3}	2.78×10^{-3}	9.476×10^{-4}	7.12×10^{-4}
τ_p	1.0226	0.226	0.0586	9.06×10^{-3}

D.C. Single Side Cooled				
Term	1	2	3	4
r_p	0.01688	4.42×10^{-3}	1.79×10^{-3}	8.72×10^{-4}
τ_p	7.055	0.5206	0.1198	0.0128

8.0 Reverse recovery ratings

- (i) Q_{ra} is based on 50% I_{rm} chord as shown in Fig. 1.
- (ii) Q_{rr} is based on a 150 μ s integration time.

i.e.
$$Q_{rr} = \int_0^{150\mu s} i_{rr} \cdot dt$$

(iii)
$$K \text{ Factor} = \frac{t1}{t2}$$

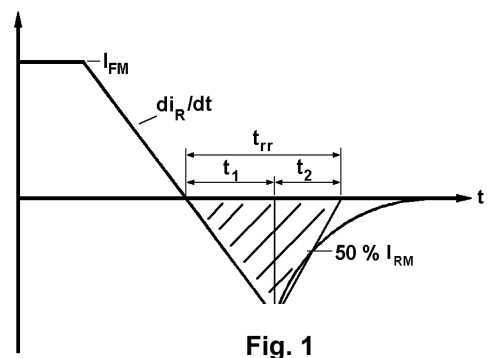

Curves

Figure 1 - On-state characteristics of Limit device

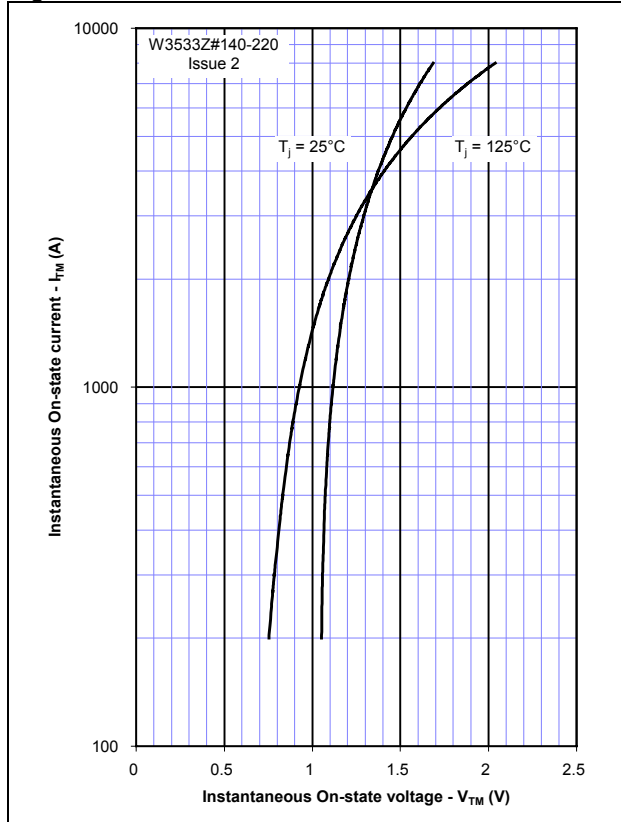

Figure 2 - Transient Thermal Impedance

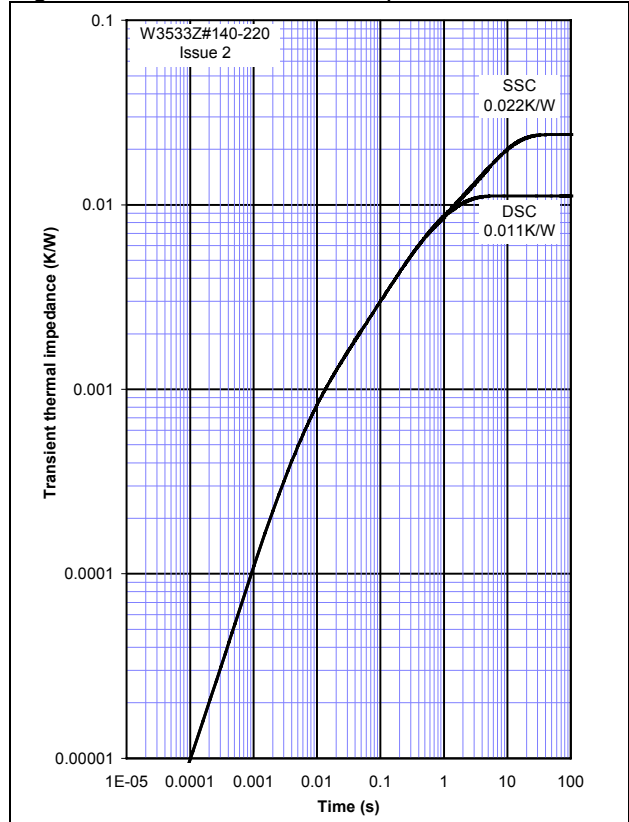

Figure 3 - Gate Characteristics - Trigger Limits

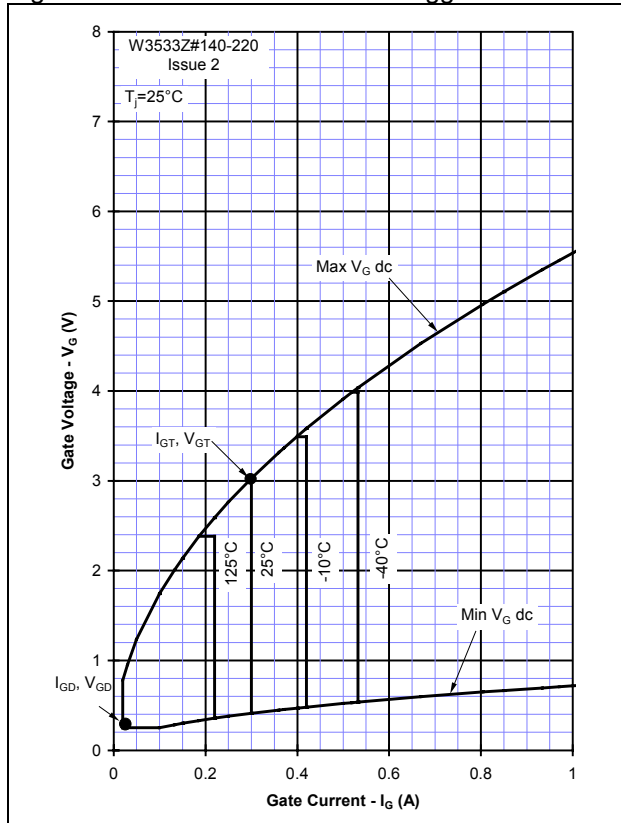

Figure 4 - Gate Characteristics - Power Curves

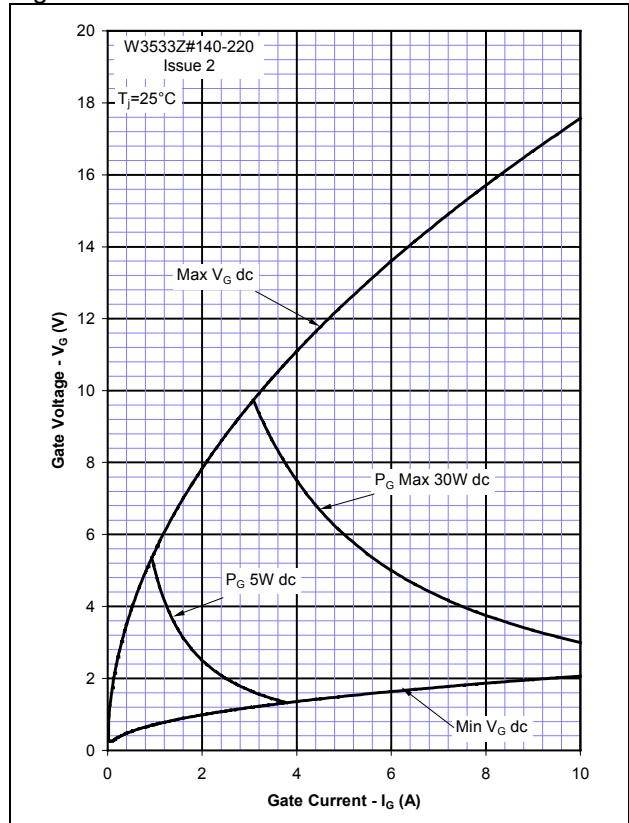

Figure 5 – Recovered Charge, Q_{rr}

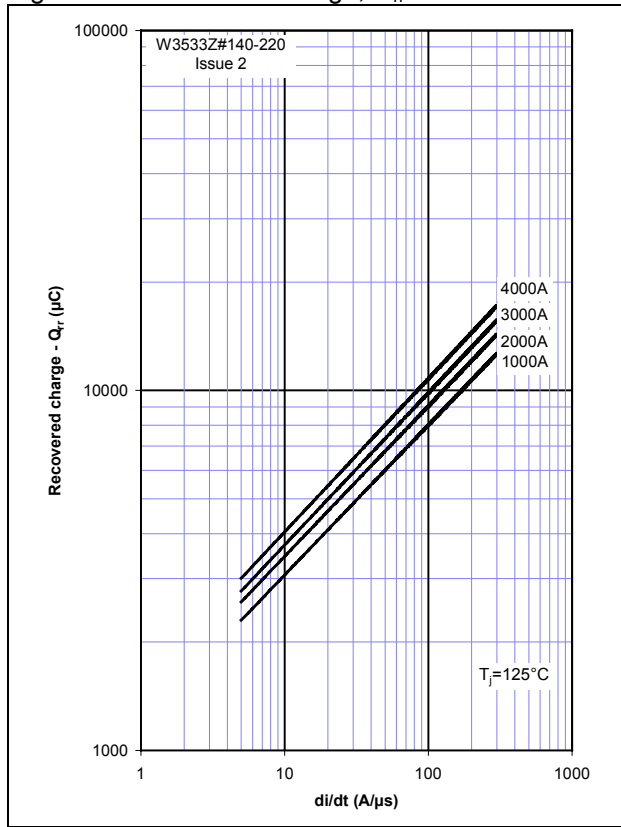

Figure 6 – Recovered charge, Q_{ra} (50% chord)

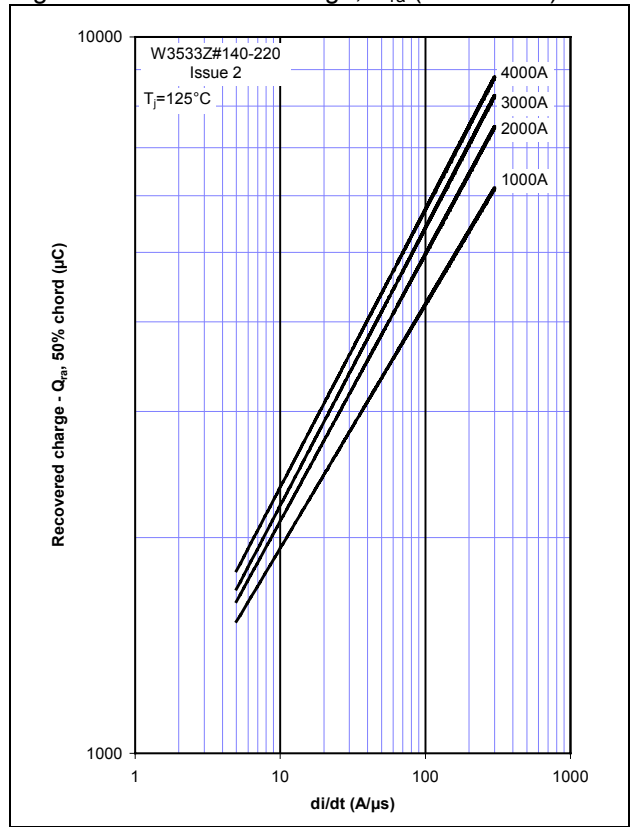

Figure 7 – Reverse recovery current, I_{rm}

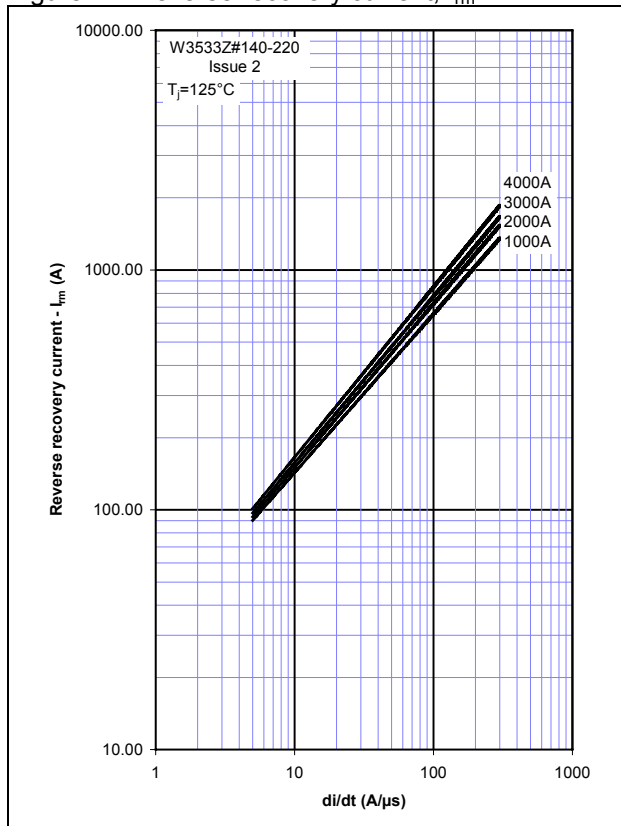

Figure 8 – Reverse recovery time, t_{rr} (50% chord)

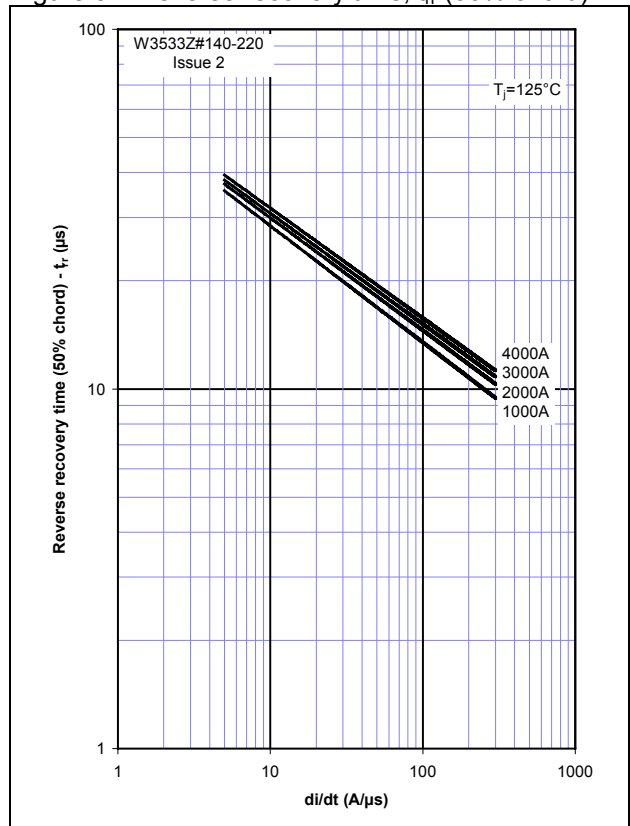

Figure 9 – On-state current vs. Power dissipation – Double Side Cooled (Sine wave)

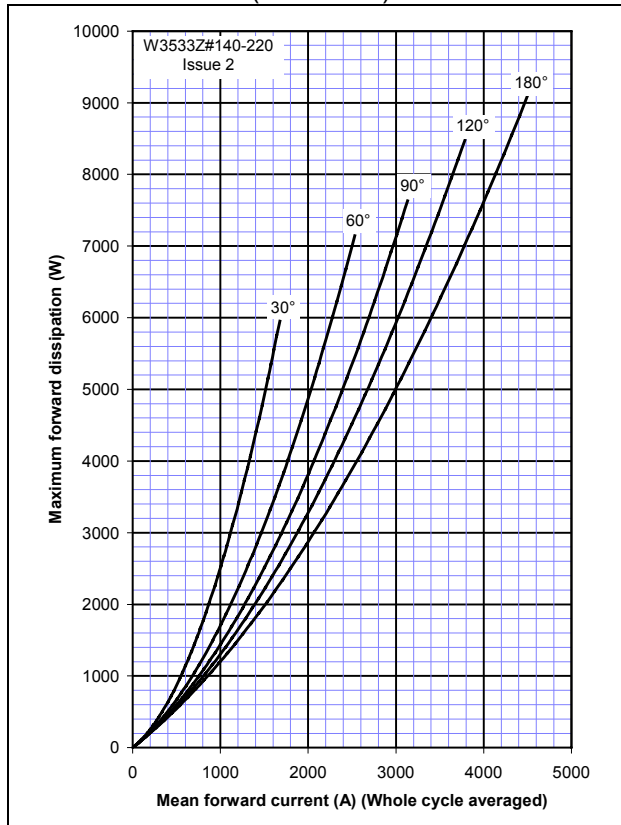

Figure 10 – On-state current vs. Heatsink temperature - Double Side Cooled (Sine wave)

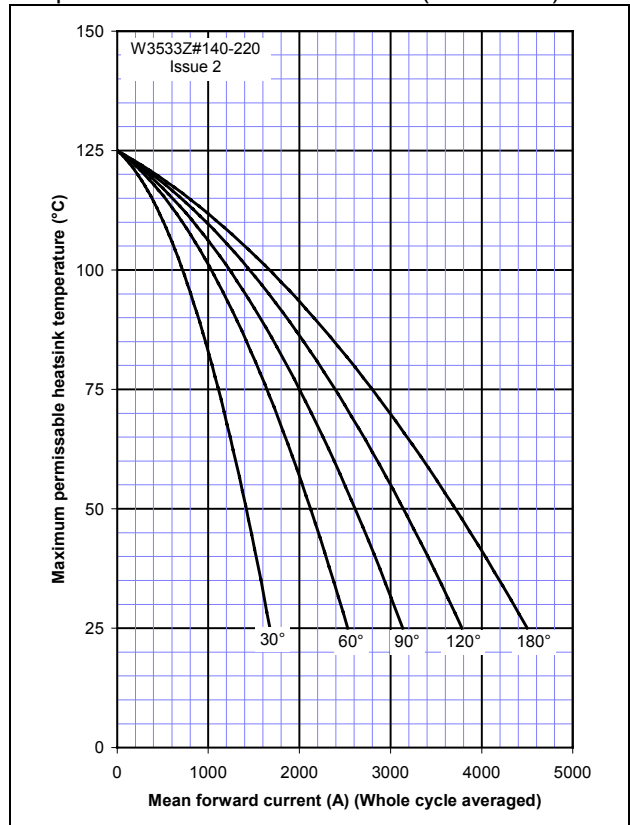

Figure 11 – On-state current vs. Power dissipation – Double Side Cooled (Square wave)

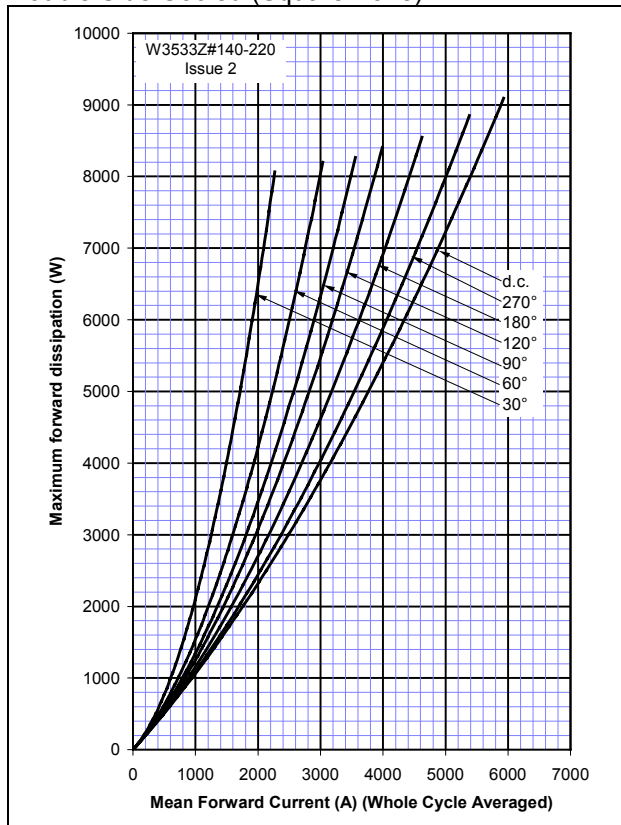

Figure 12 – On-state current vs. Heatsink temperature - Double Side Cooled (Square wave)

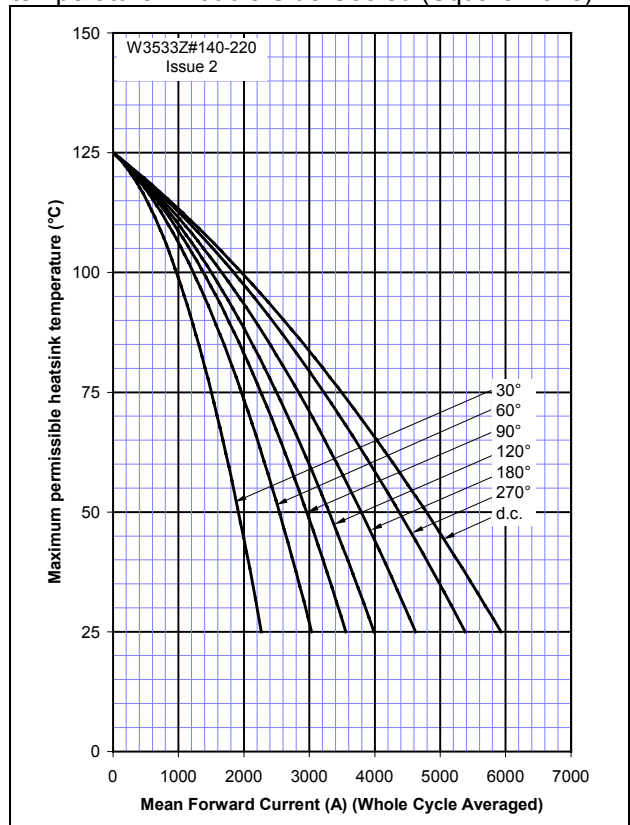

Figure 13 – On-state current vs. Power dissipation – Single Side Cooled (Sine wave)

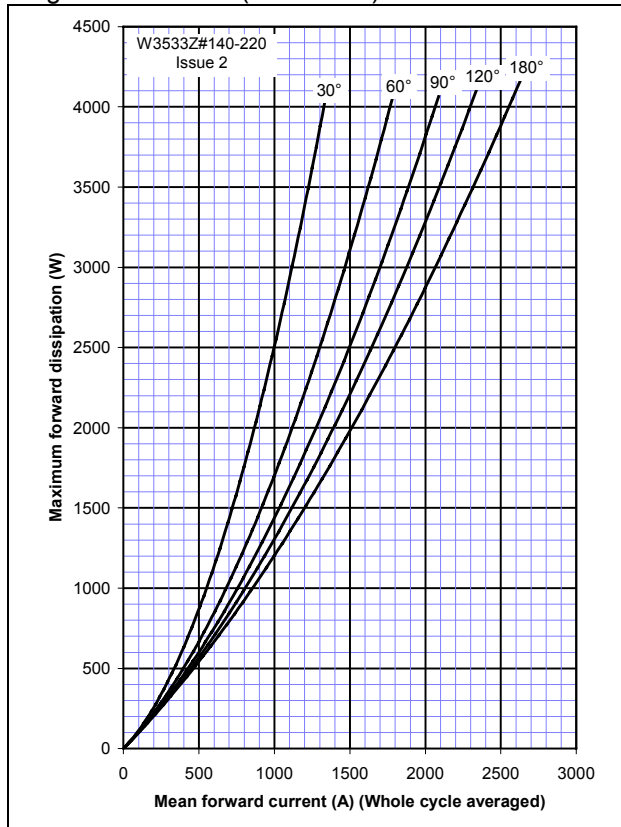

Figure 14 – On-state current vs. Heatsink temperature - Single Side Cooled (Sine wave)

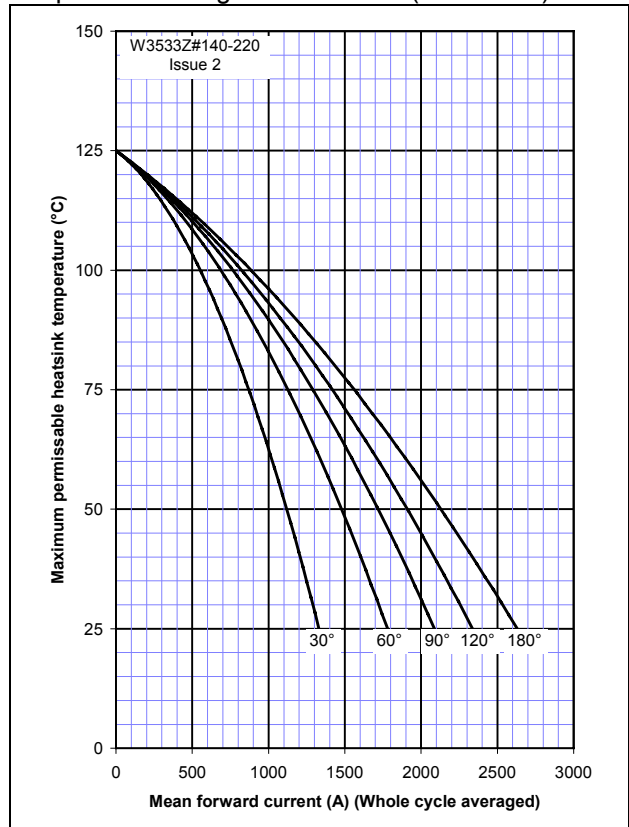

Figure 15 – On-state current vs. Power dissipation – Single Side Cooled (Square wave)

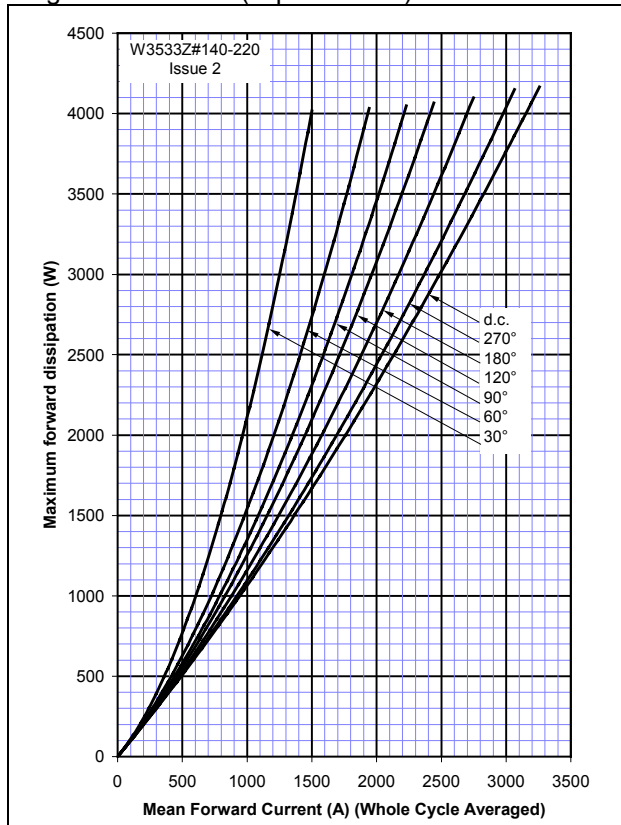

Figure 16 – On-state current vs. Heatsink temperature - Single Side Cooled (Square wave)

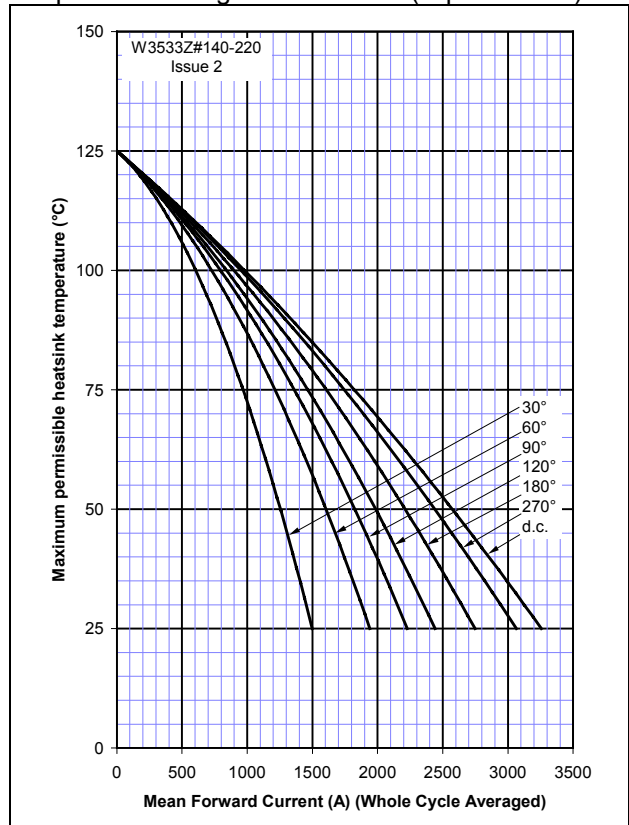
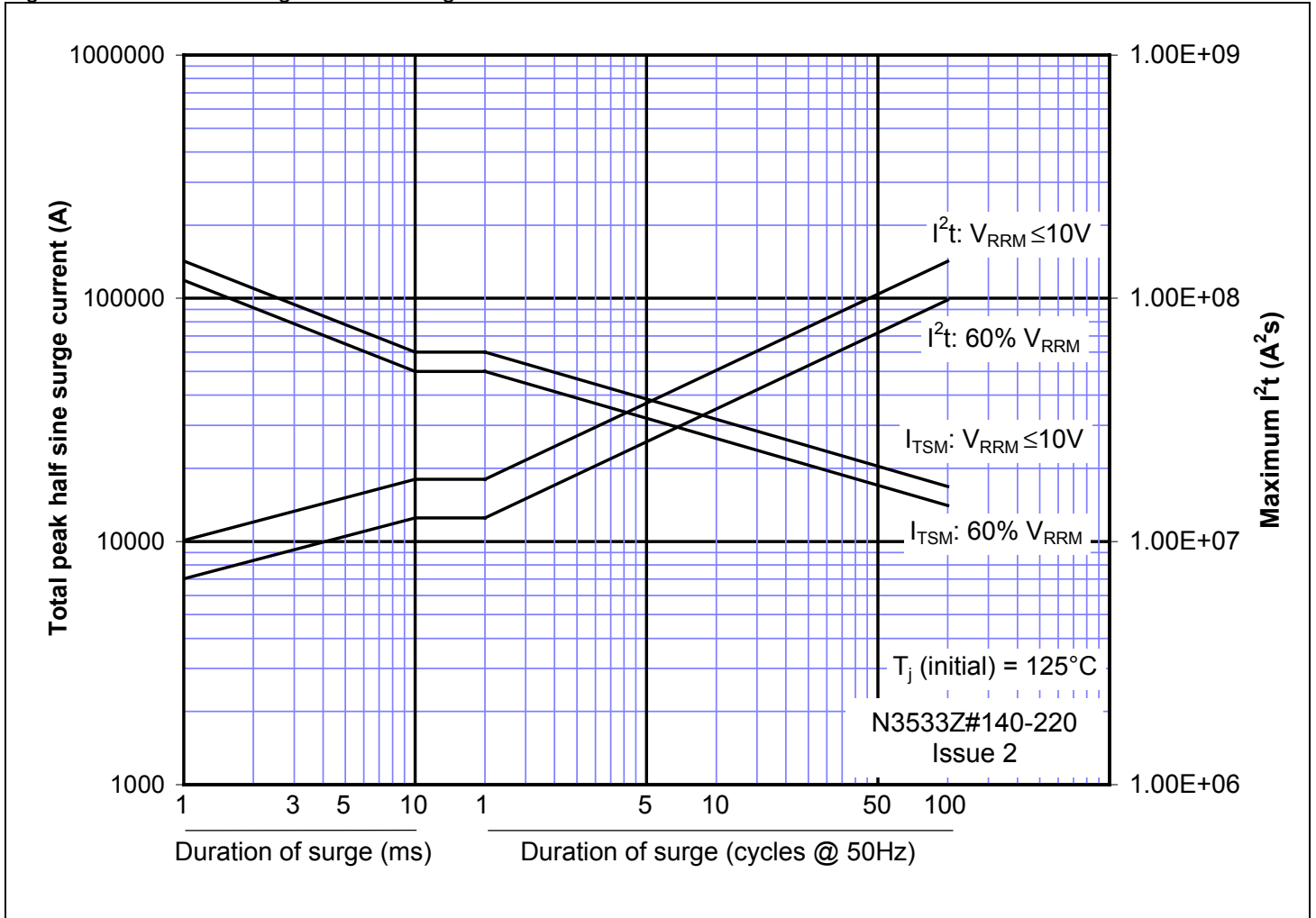
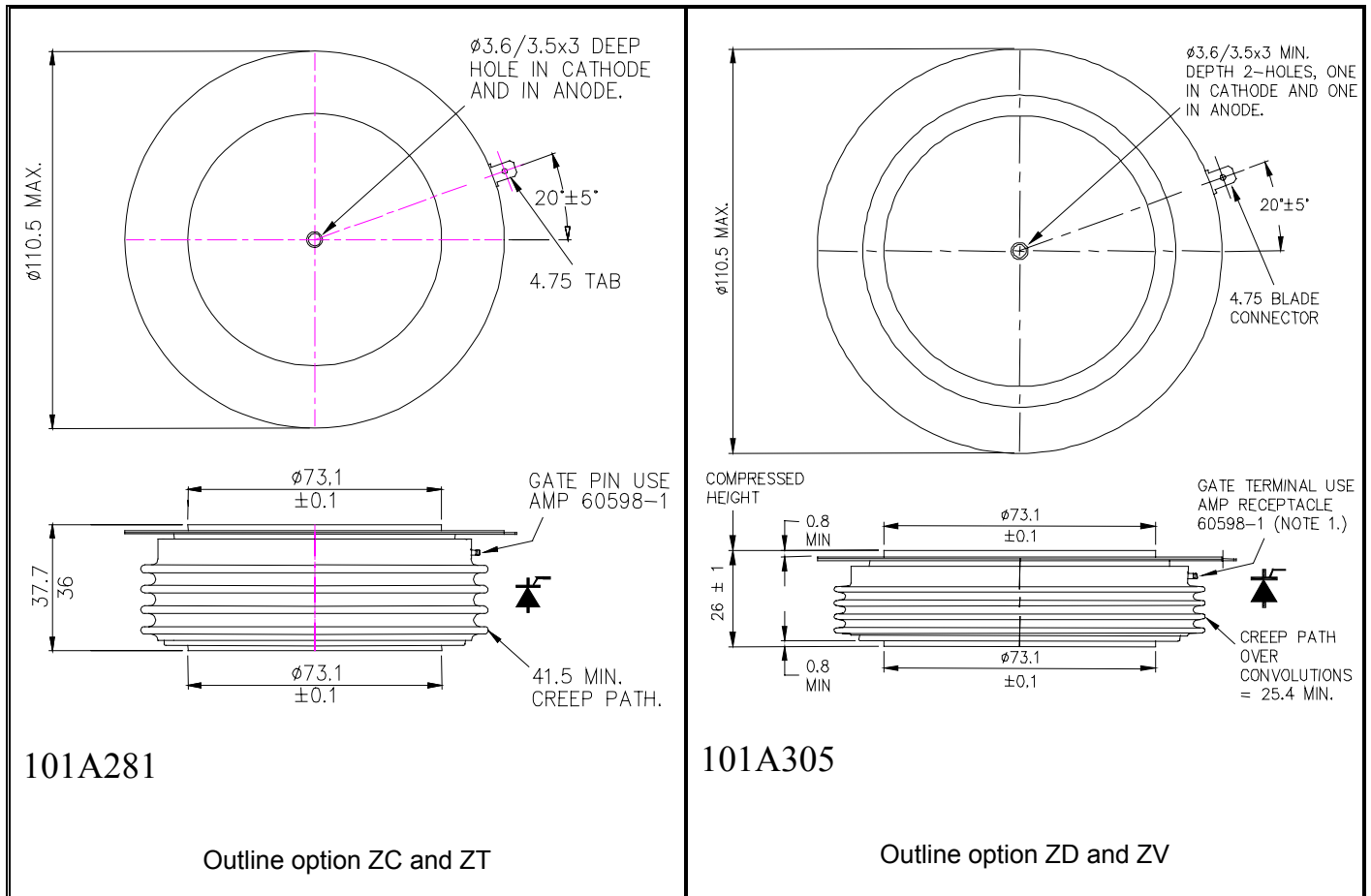

Figure 17 – Maximum surge and I^2t Ratings



Outline Drawing & Ordering Information



101A281

Outline option ZC and ZT

101A305

Outline option ZD and ZV

ORDERING INFORMATION

(Please quote 10 digit code as below)

N3533	Z#	◆◆	0
Fixed Type Code	Outline code ZC = 37.7mm clamp height, ZT = 37.7mm clamp height, rupture rated ZD = 26mm clamp height, ZV = 26mm clamp height, rupture rated	Voltage code V _{DRM} /100 14-22	Fixed turn-off time code

Order code: N3533ZD220 – 2200V V_{RRM}, 26mm clamp height capsule.

IXYS Semiconductor GmbH
Edisonstraße 15
D-68623 Lampertheim
Tel: +49 6206 503-0
Fax: +49 6206 503-627
E-mail: marcom@ixys.de

WESTCODE
An IXYS Company

Westcode Semiconductors Ltd
PO Box 57 Chippenham
Wiltshire SN15 1JL
Tel: +44 (0)1249 444524
Fax: +44 (0)1249 659448
E-mail: WSL.sales@westcode.com

IXYS Corporation
3540 Bassett Street
Santa Clara CA 95054 USA
Tel: +1 (408) 982 0700
Fax: +1 (408) 496 0670
E-mail: sales@ixys.net

www.westcode.com

www.ixys.net

Westcode Semiconductors Inc
3270 Cherry Avenue
Long Beach CA 90807 USA
Tel: +1 (562) 595 6971
Fax: +1 (562) 595 8182
E-mail: WSI.sales@westcode.com

The information contained herein is confidential and is protected by Copyright. The information may not be used or disclosed except with the written permission of and in the manner permitted by the proprietors Westcode Semiconductors Ltd.

© Westcode Semiconductors Ltd.

In the interest of product improvement, Westcode reserves the right to change specifications at any time without prior notice.

Devices with a suffix code (2-letter or letter/digit/letter combination) added to their generic code are not necessarily subject to the conditions and limits contained in this report.