

## PHASE CONTROL THYRISTOR

# AT870LT

Repetitive voltage up to **4200 V**

Mean forward current **3276 A**

Surge current **50 kA**

### FINAL SPECIFICATION

Nov. 18 - Issue: 0

Symbol	Characteristic	Conditions	T <sub>j</sub> [°C]	Value	Unit
<b>BLOCKING</b>					
V <sub>RRM</sub>	Repetitive peak reverse voltage		125	4200	V
V <sub>RSM</sub>	Non-repetitive peak reverse voltage		125	4300	V
V <sub>DRM</sub>	Repetitive peak off-state voltage		125	4200	V
I <sub>RRM</sub>	Repetitive peak reverse current	V=VRRM	125	300	mA
I <sub>DRM</sub>	Repetitive peak off-state current	V=VDRM	125	300	mA
<b>CONDUCTING</b>					
I <sub>T(AV)</sub>	Mean forward current	180° sin ,50 Hz, Th=55°C, double side cooled		3276	A
I <sub>T(AV)</sub>	Mean forward current	180° sin ,50 Hz, Tc=85°C, double side cooled		2568	A
I <sub>TSM</sub>	Surge forward current	Sine wave, 10 ms	125	50	kA
I <sup>2</sup> t	I <sup>2</sup> t	without reverse voltage		12500 x 10 <sup>3</sup>	A <sup>2</sup> s
V <sub>T</sub>	On-state voltage	On-state current = 2000 A	25	1,61	V
V <sub>T(TO)</sub>	Threshold voltage		125	1,00	V
r <sub>T</sub>	On-state slope resistance		125	0,170	mohm
<b>SWITCHING</b>					
di/dt	Critical rate of rise of on-state current, min.	From 75% VDRM up to 1600 A; gate 10V, 5Ω	125	200	A/μs
dv/dt	Critical rate of rise of off-state voltage, min.	Linear ramp up to 70% of VDRM	125	1000	V/μs
t <sub>d</sub>	Gate controlled delay time, typical	VD=100V; gate source 40V, 10Ω, tr=.5 μs	25	3	μs
t <sub>q</sub>	Circuit commutated turn-off time, typical	dv/dt = 20 V/μs linear up to 75% VDRM		400	μs
Q <sub>rr</sub>	Reverse recovery charge	di/dt = -20 A/μs, I= 1050 A	125		μC
I <sub>rr</sub>	Peak reverse recovery current	VR= 50 V			A
I <sub>H</sub>	Holding current, typical	VD=5V, gate open circuit	25	300	mA
I <sub>L</sub>	Latching current, typical	VD=12V, tp=30μs	25	1000	mA
<b>GATE</b>					
V <sub>GT</sub>	Gate trigger voltage	VD=12V	25	3,50	V
I <sub>GT</sub>	Gate trigger current	VD=12V	25	400	mA
V <sub>GD</sub>	Non-trigger gate voltage, min.	VD=VDRM	125	0,80	V
V <sub>FGM</sub>	Peak gate voltage (forward)			30	V
I <sub>FGM</sub>	Peak gate current			10	A
V <sub>RGM</sub>	Peak gate voltage (reverse)			10	V
P <sub>GM</sub>	Peak gate power dissipation	Pulse width 100 μs		150	W
P <sub>G</sub>	Average gate power dissipation			2	W
<b>MOUNTING</b>					
R <sub>th(j-h)</sub>	Thermal impedance, DC	Junction to heatsink, double side cooled		9,0	°C/kW
R <sub>th(c-h)</sub>	Thermal impedance	Case to heatsink, double side cooled		1,5	°C/kW
T <sub>j</sub>	Operating junction temperature			-30 / 125	°C
F	Mounting force			60.0 / 80.0	kN
	Mass			1700	g

### ORDERING INFORMATION : AT870LT S 42

standard specification   VRRM/100

DISSIPATION CHARACTERISTICS

SQUARE WAVE

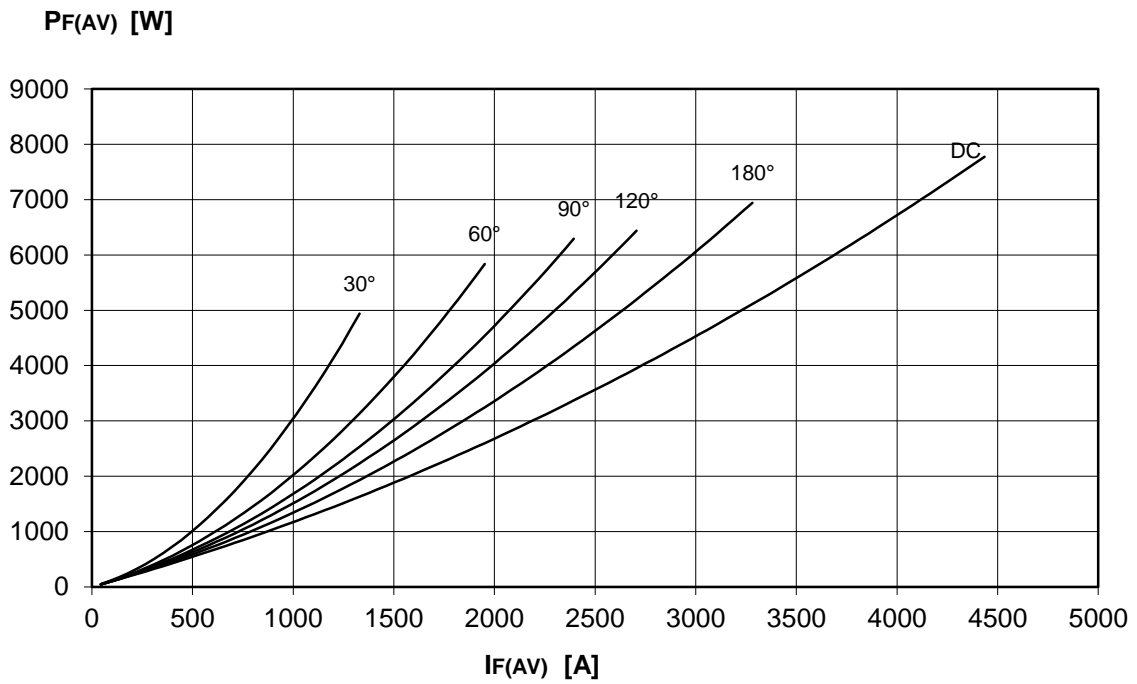
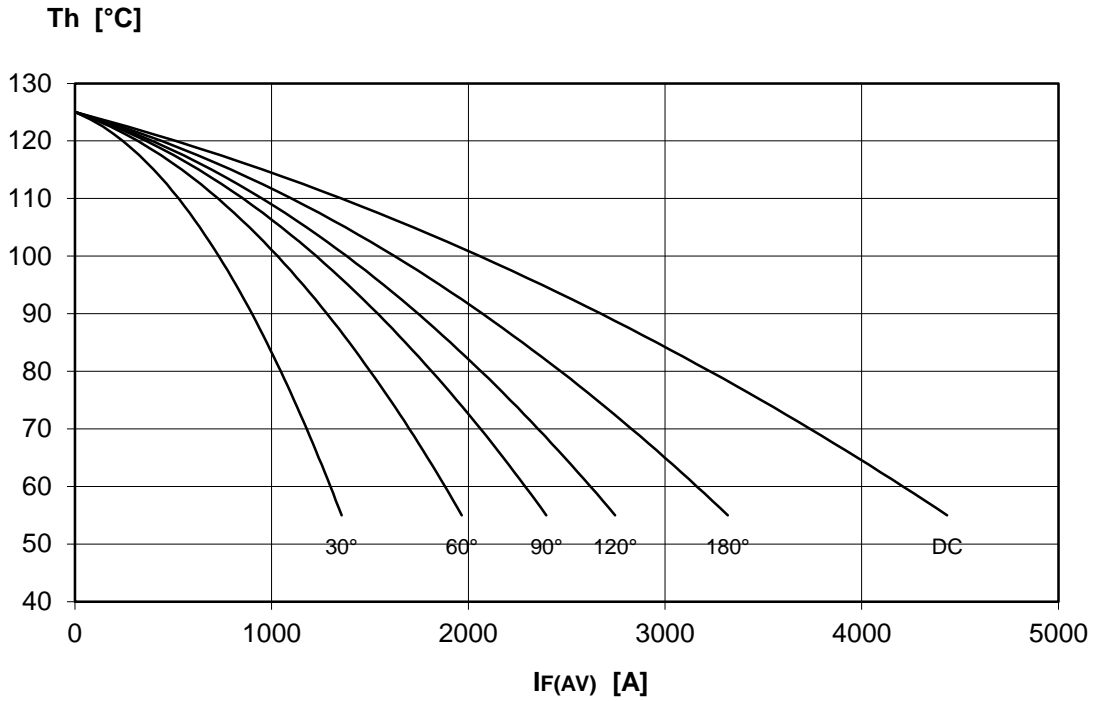

## DISSIPATION CHARACTERISTICS

SINE WAVE

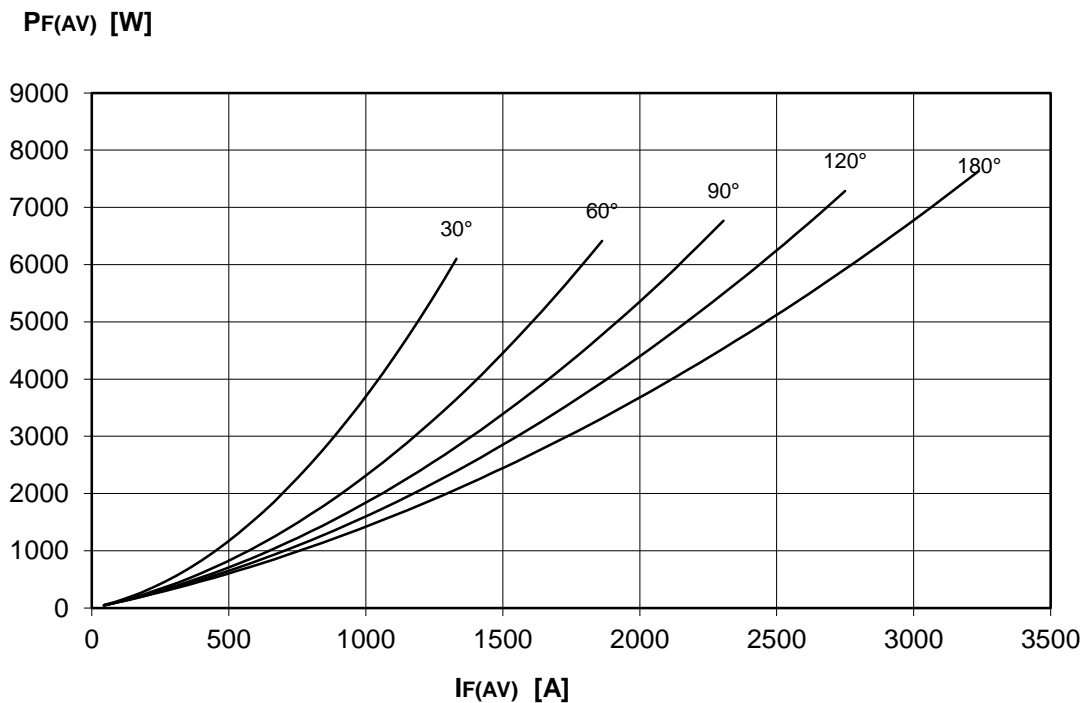
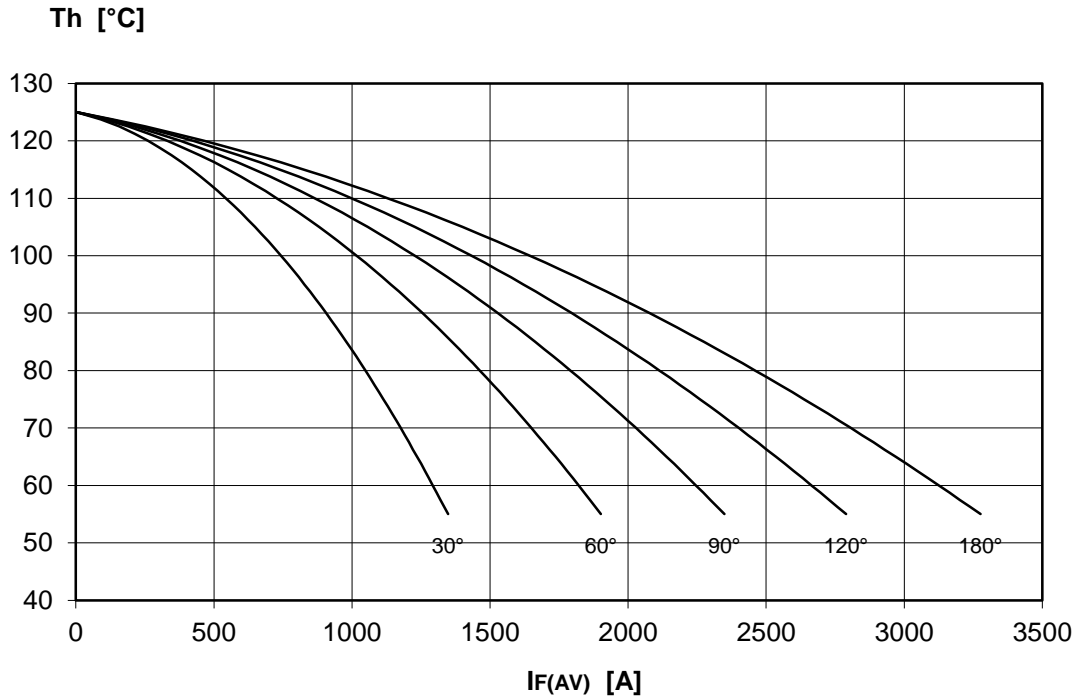

# AT870LT PHASE CONTROL THYRISTOR



FINAL SPECIFICATION Nov. 18 - Issue: 0

ON-STATE CHARACTERISTIC  
T<sub>j</sub> = 125 °C

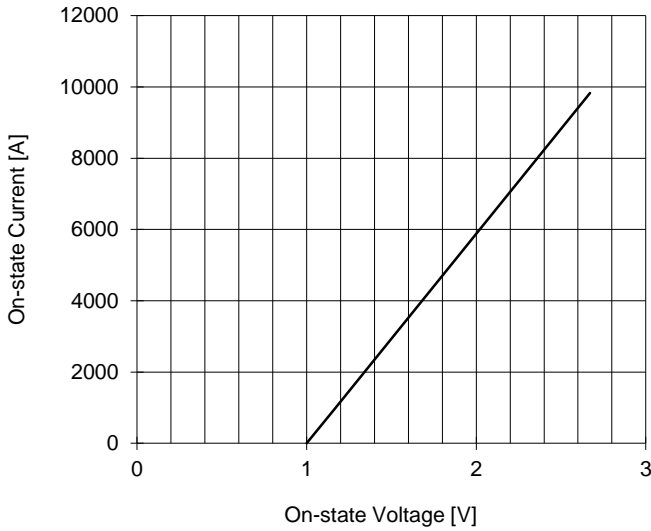

SURGE CHARACTERISTIC  
T<sub>j</sub> = 125 °C

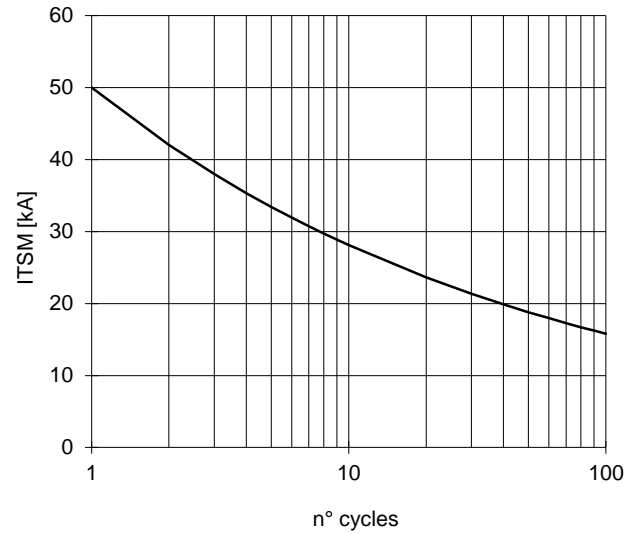

TRANSIENT THERMAL IMPEDANCE  
DOUBLE SIDE COOLED

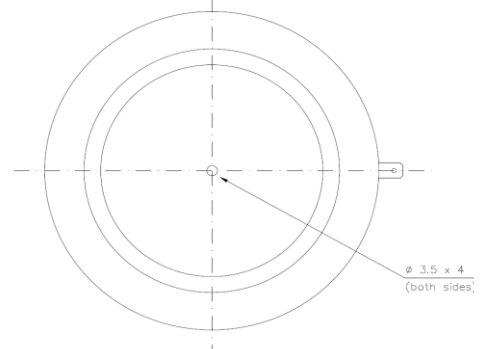
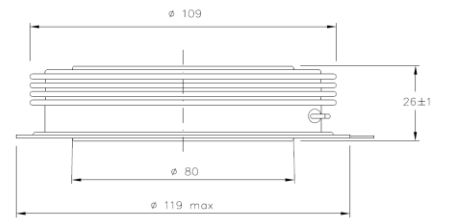
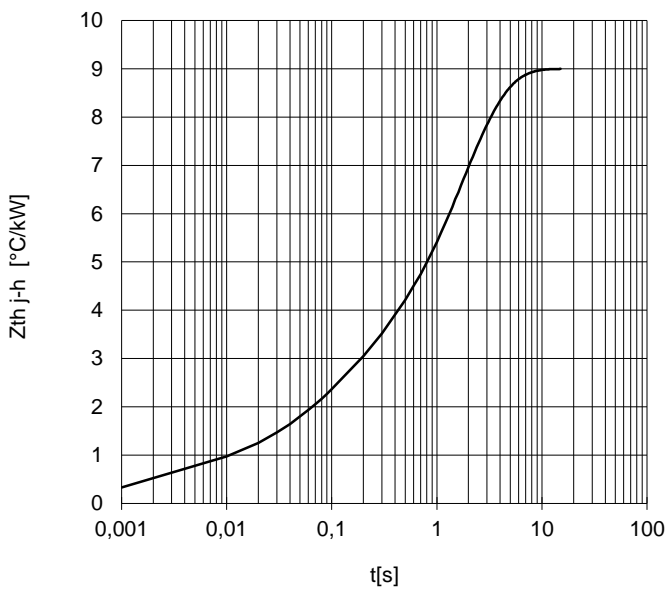

Dimensions  
in mm

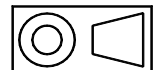

Cathode terminal type DIN 46244 - A 4.8 - 0.8

Gate terminal type AMP 60598 - 1

Distributed by

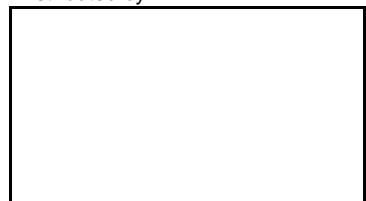

All the characteristics given in this data sheet are guaranteed only with uniform clamping force, cleaned and lubricated heatsink, surfaces with flatness < .03 mm and roughness < 2 μm. In the interest of product improvement POSEICO SpA reserves the right to change any data given in this data sheet at any time without previous notice. If not stated otherwise the maximum value of ratings (symbols over shaded background) and characteristics is reported.