

## PHASE CONTROL THYRISTOR

# AT505

Repetitive voltage up to **1600 V**

Mean forward current **429 A**

Surge current **5,6 kA**

### FINAL SPECIFICATION

Feb. 17 - Issue: 6

| Symbol               | Characteristic                                   | Conditions                                   | T <sub>j</sub><br>[°C] | Value                 | Unit             |
|----------------------|--|--|------------------------|-----------------------|------------------|
| <b>BLOCKING</b>      |  |  |                        |                       |                  |
| V <sub>RRM</sub>     | Repetitive peak reverse voltage                  |  | 125                    | 1600                  | V                |
| V <sub>RSM</sub>     | Non-repetitive peak reverse voltage              |  | 125                    | 1700                  | V                |
| V <sub>DRM</sub>     | Repetitive peak off-state voltage                |  | 125                    | 1600                  | V                |
| I <sub>RRM</sub>     | Repetitive peak reverse current                  | V=VRRM                                       | 125                    | 30                    | mA               |
| I <sub>DRM</sub>     | Repetitive peak off-state current                | V=VDRM                                       | 125                    | 30                    | mA               |
| <b>CONDUCTING</b>    |  |  |                        |                       |                  |
| I <sub>T(AV)</sub>   | Mean forward current                             | 180° sin, 50 Hz, Th=55°C, double side cooled |                        | 429                   | A                |
| I <sub>T(AV)</sub>   | Mean forward current                             | 180° sin, 50 Hz, Tc=85°C, double side cooled |                        | 340                   | A                |
| I <sub>TSM</sub>     | Surge forward current                            | Sine wave, 10 ms                             | 125                    | 5,6                   | kA               |
| I <sup>2</sup> t     | I <sup>2</sup> t                                 | without reverse voltage                      |                        | 157 x 10 <sup>3</sup> | A <sup>2</sup> s |
| V <sub>T</sub>       | On-state voltage                                 | On-state current = 800 A                     | 25                     | 1,55                  | V                |
| V <sub>T(TO)</sub>   | Threshold voltage                                |  | 125                    | 1,00                  | V                |
| r <sub>T</sub>       | On-state slope resistance                        |  | 125                    | 0,680                 | mohm             |
| <b>SWITCHING</b>     |  |  |                        |                       |                  |
| di/dt                | Critical rate of rise of on-state current, min.  | From 75% VDRM up to 450 A; gate 10V, 5Ω      | 125                    | 200                   | A/μs             |
| dv/dt                | Critical rate of rise of off-state voltage, min. | Linear ramp up to 70% of VDRM                | 125                    | 500                   | V/μs             |
| t <sub>d</sub>       | Gate controlled delay time, typical              | VD=100V; gate source 10V, 10Ω, tr=.5 μs      | 25                     | 1,6                   | μs               |
| t <sub>q</sub>       | Circuit commutated turn-off time, typical        | dv/dt = 20 V/μs linear up to 75% VDRM        |                        | 200                   | μs               |
| Q <sub>rr</sub>      | Reverse recovery charge                          | di/dt = -20 A/μs, I= 290 A                   | 125                    |                       | μC               |
| I <sub>rr</sub>      | Peak reverse recovery current                    | VR= 50 V                                     |                        |                       | A                |
| I <sub>H</sub>       | Holding current, typical                         | VD=5V, gate open circuit                     | 25                     | 300                   | mA               |
| I <sub>L</sub>       | Latching current, typical                        | VD=5V, tp=30μs                               | 25                     | 700                   | mA               |
| <b>GATE</b>          |  |  |                        |                       |                  |
| V <sub>GT</sub>      | Gate trigger voltage                             | VD=5V  | 25                     | 3,50                  | V                |
| I <sub>GT</sub>      | Gate trigger current                             | VD=5V  | 25                     | 200                   | mA               |
| V <sub>GD</sub>      | Non-trigger gate voltage, min.                   | VD=VDRM                                      | 125                    | 0,25                  | V                |
| V <sub>FGM</sub>     | Peak gate voltage (forward)                      |  |                        | 20                    | V                |
| I <sub>FGM</sub>     | Peak gate current                                |  |                        | 8                     | A                |
| V <sub>RGM</sub>     | Peak gate voltage (reverse)                      |  |                        | 5                     | V                |
| P <sub>GM</sub>      | Peak gate power dissipation                      | Pulse width 100 μs                           |                        | 75                    | W                |
| P <sub>G</sub>       | Average gate power dissipation                   |  |                        | 1                     | W                |
| <b>MOUNTING</b>      |  |  |                        |                       |                  |
| R <sub>th(j-h)</sub> | Thermal impedance, DC                            | Junction to heatsink, double side cooled     |                        | 95,0                  | °C/kW            |
| R <sub>th(c-h)</sub> | Thermal impedance                                | Case to heatsink, double side cooled         |                        | 20,0                  | °C/kW            |
| T <sub>j</sub>       | Operating junction temperature                   |  |                        | -30 / 125             | °C               |
| F                    | Mounting force                                   |  |                        | 4,9 / 5,9             | kN               |
|                      | Mass   |  |                        | 55                    | g                |

### ORDERING INFORMATION : AT505 S 16

standard specification   VRRM/100



DISSIPATION CHARACTERISTICS

SINE WAVE

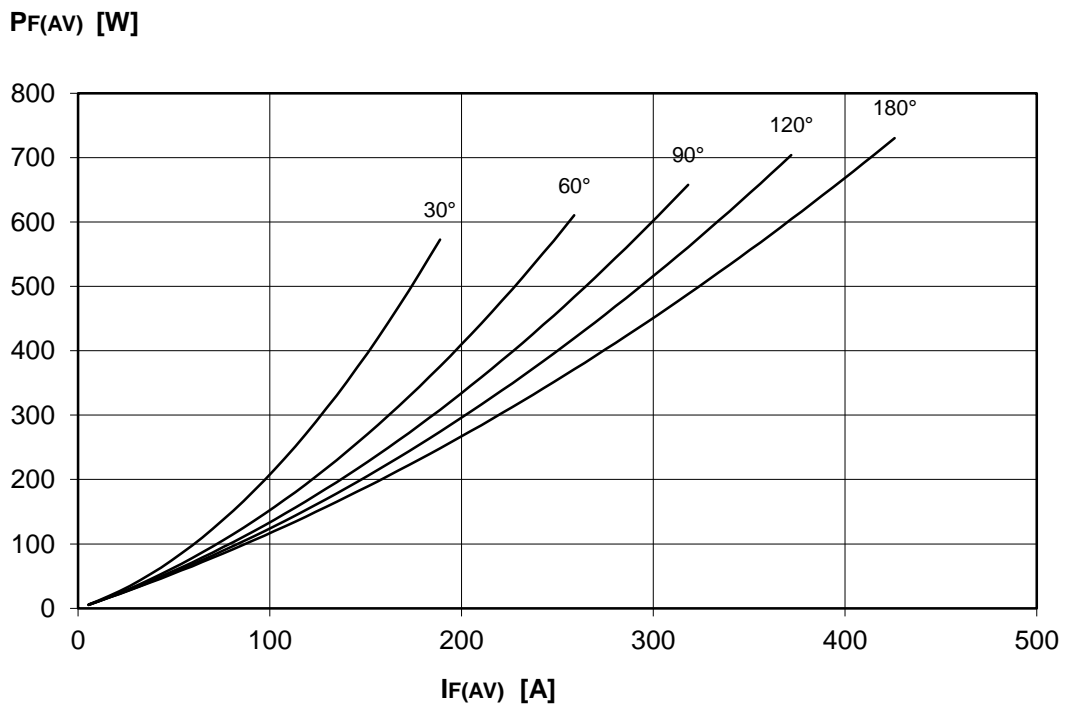
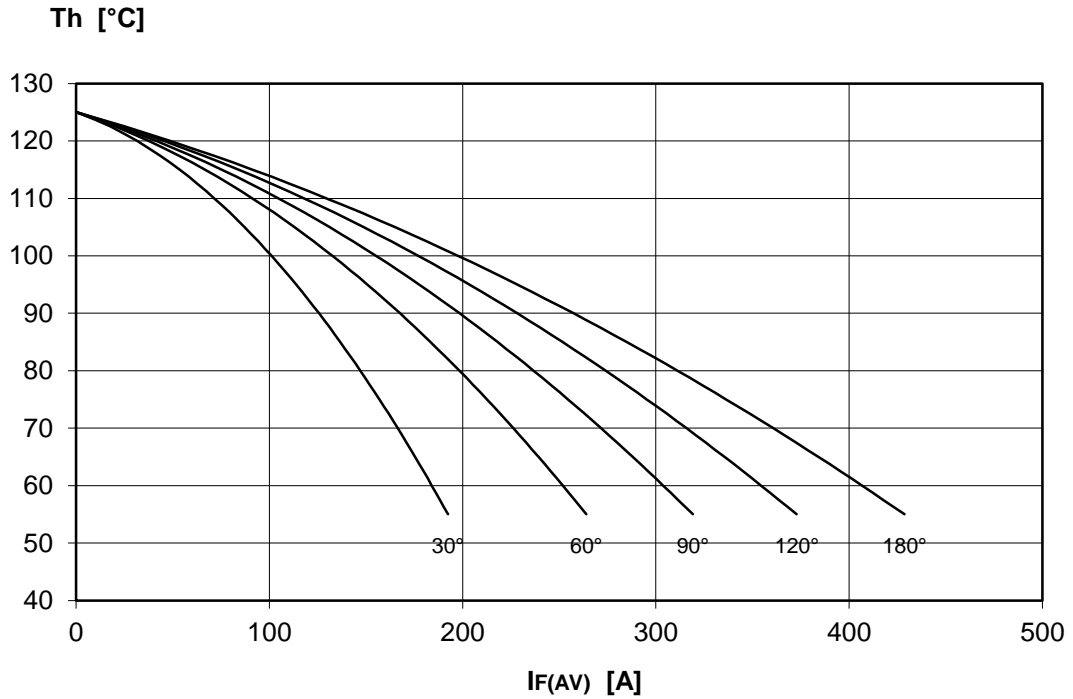

# AT505 PHASE CONTROL THYRISTOR



FINAL SPECIFICATION Feb. 17 - Issue: 6

ON-STATE CHARACTERISTIC  
T<sub>j</sub> = 125 °C

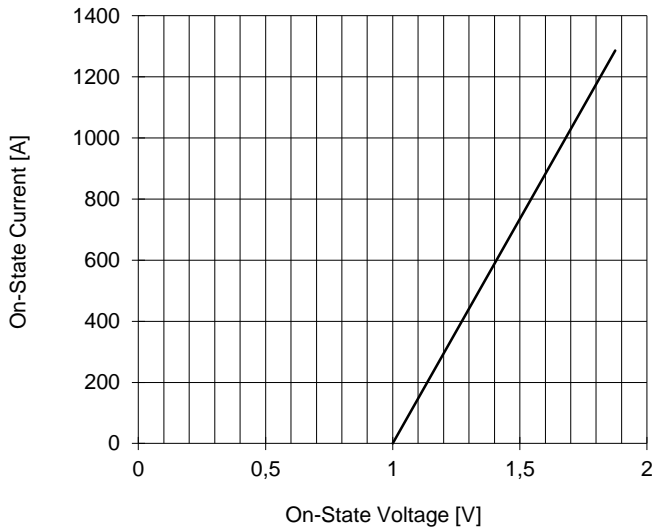

SURGE CHARACTERISTIC  
T<sub>j</sub> = 125 °C

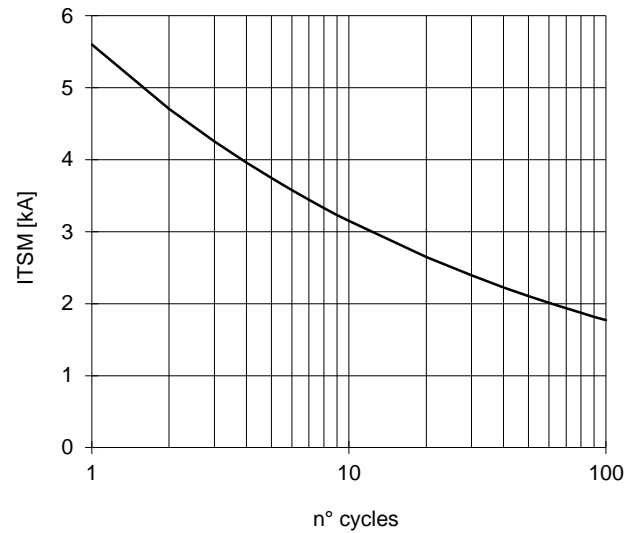

TRANSIENT THERMAL IMPEDANCE  
DOUBLE SIDE COOLED

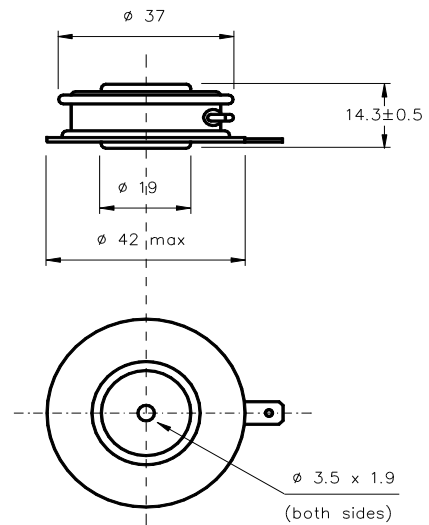
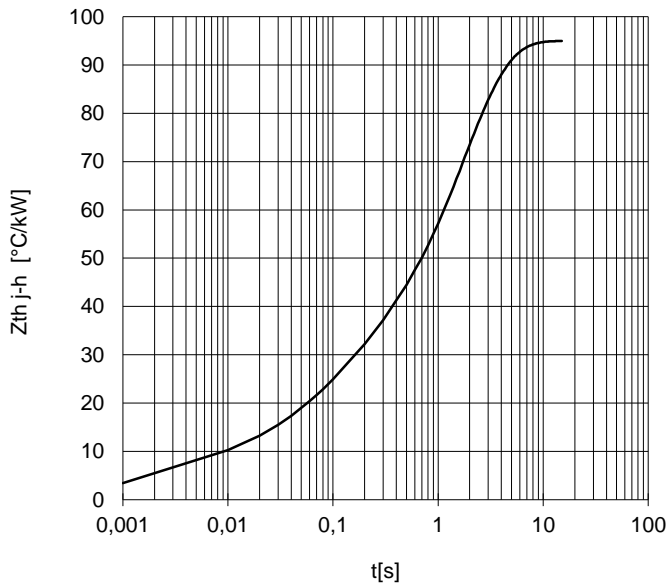

Dimensions  
in mm



Cathode terminal type DIN 46244 - A 4.8 - 0.8

Gate terminal type AMP 60598 - 1

Distributed by

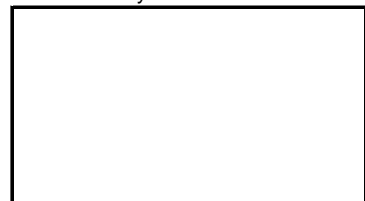

All the characteristics given in this data sheet are guaranteed only with uniform clamping force, cleaned and lubricated heatsink, surfaces with flatness < .03 mm and roughness < 2 μm. In the interest of product improvement POSEICO SpA reserves the right to change any data given in this data sheet at any time without previous notice. If not stated otherwise the maximum value of ratings (symbols over shaded background) and characteristics is reported.