



Stud Diode

Avalanche Diode

SKNa 102

Publish Data

Features

- Avalanche type reverse characteristic
- Reverse voltages up to 5000 V
- Hermetic metal case with ceramic insulator and extra long creepage distances
- Threaded stud ISO M12
- Cooling via heatsinks
- SKN: Anode to stud

Typical Applications*

- High voltage rectifier diode for traction and heavy duty applications
- Series connections for high voltage applications
- Non-controllable and half-controllable rectifiers
- Free-wheeling diodes

$V_{(BR)min}$ V	$I_{FRMS} = 200$ A (maximum value for continuous operation) $I_{FAV} = 125$ A (sin. 180; $T_c = 80$ °C)	C_{max} μ F	R_{min} Ω
3600	SKNa 102/36		
4000	SKNa 102/40		
4200	SKNa 102/42		
4500	SKNa 102/45		
4600	SKNa 102/46		
4800	SKNa 102/48		
5000	SKNa 102/50		

Symbol	Conditions	Values	Units
I_{FAV}	sin. 180 ; $T_c = 80$ (102) °C	125 (100)	A
I_D	K 1,1; $T_a = 45$ °C; B2 / B6	114 / 162	A
	K 1,1F; $T_a = 35$ °C; B2 / B6	189 / 266	A
I_{FSM}	$T_{vj} = 25$ °C; 10 ms	1900	A
	$T_{vj} = 160$ °C; 10 ms	1600	A
i^2t	$T_{vj} = 25$ °C; 8,3 ... 10 ms	18000	A ² s
	$T_{vj} = 160$ °C; 8,3 ... 10 ms	12500	A ² s
V_F	$T_{vj} = 25$ °C; $I_F = 300$ A	max. 1,9	V
$V_{(TO)}$	$T_{vj} = 150$ °C	max. 1	V
r_T	$T_{vj} = 150$ °C	max. 3,7	m Ω
I_{RD}	$T_{vj} = 25$ °C; $V_{RD} = V_{(BR)min}$	max. 1000	μ A
	$T_{vj} = 160$ °C; $V_{RD} = V_{(BR)min}$	max. 15	mA
P_{RSM}	$T_{vj} = 160$ °C; $t_p = 10$ μ s	36	kW
$R_{th(j-c)}$		0,3	K/W
$R_{th(c-s)}$		0,08	K/W
T_{vj}		- 40 ... + 160	°C
T_{stg}		- 40 ... + 160	°C
V_{isol}		-	V~
M_s	to heatsink	10	Nm
		90	lb.in.
a		5 * 9,81	m/s ²
m	approx.	110	g
Case		E 44	

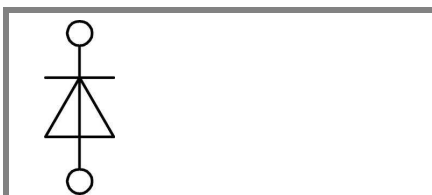

SKN

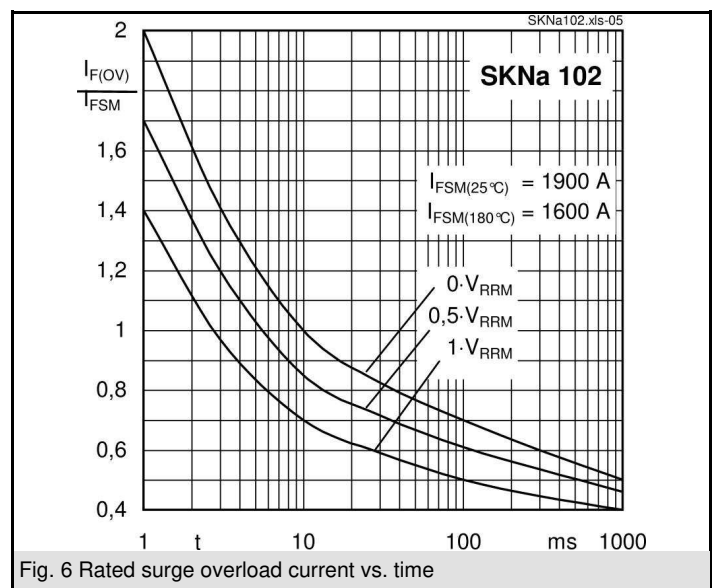
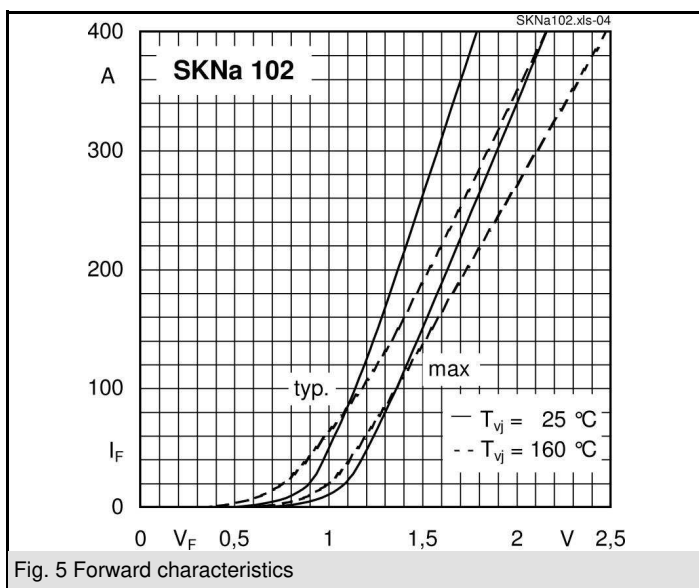
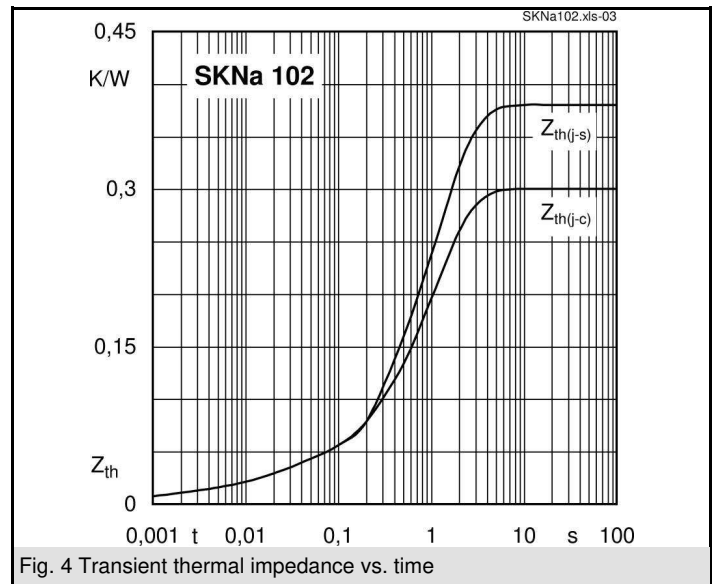
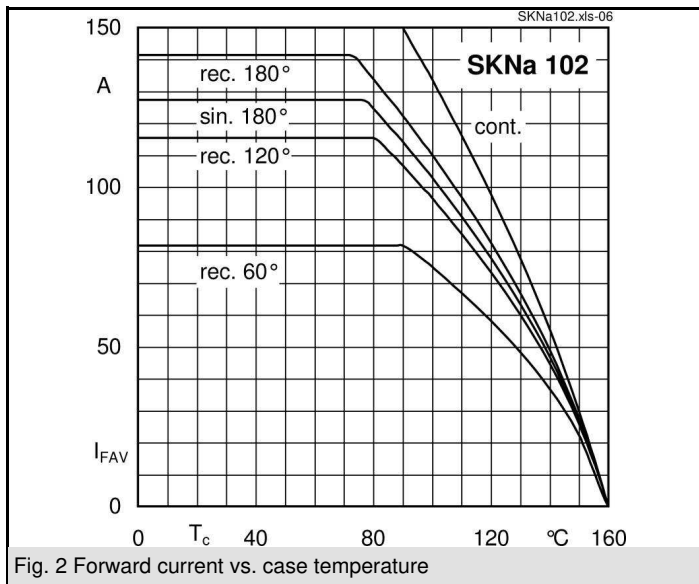
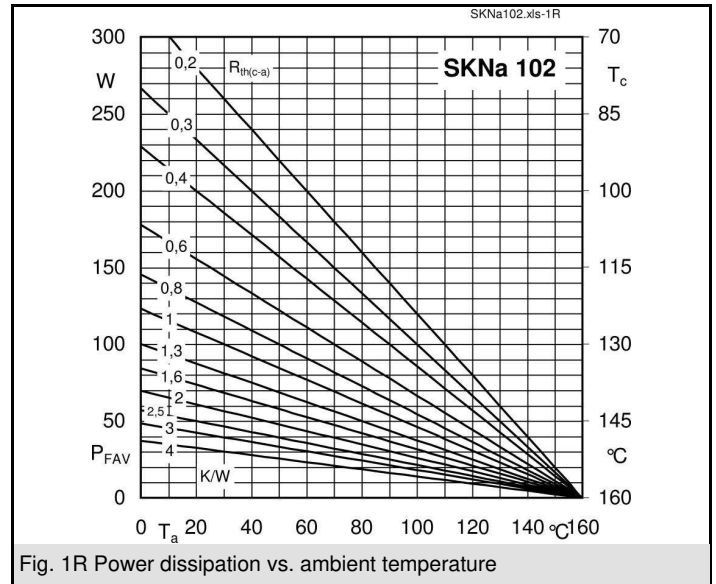
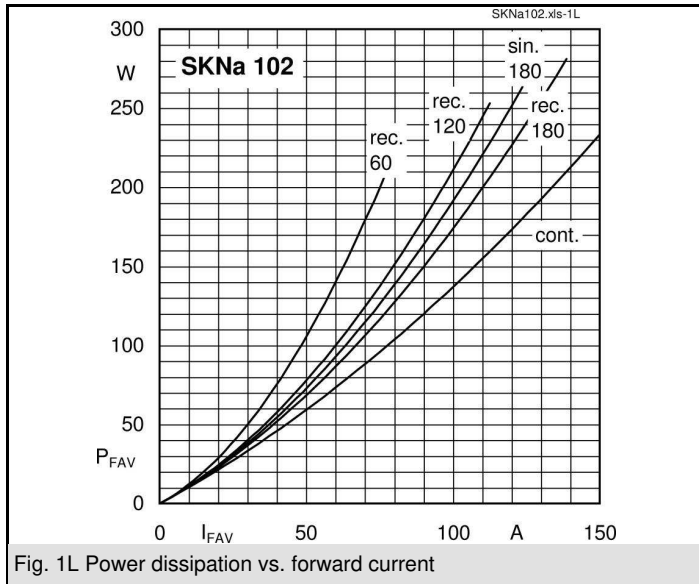

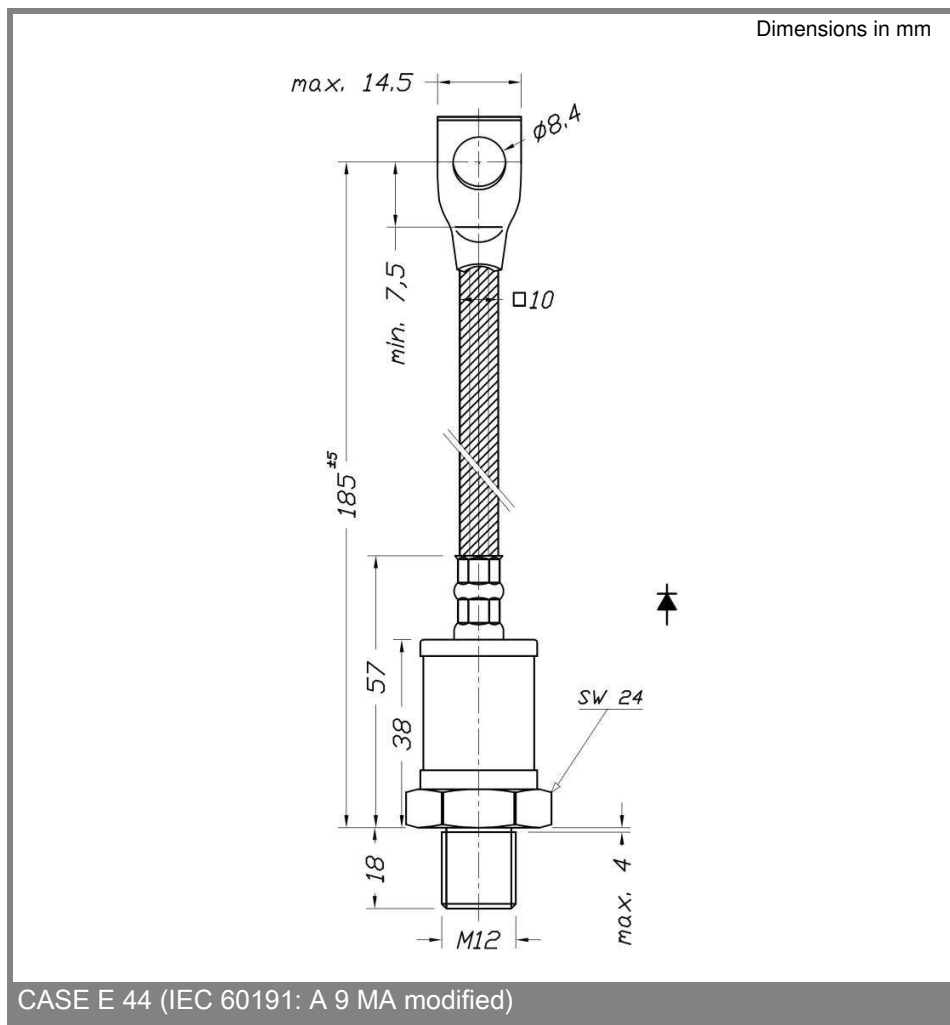

* The specifications of our components may not be considered as an assurance of component characteristics. Components have to be tested for the respective application. Adjustments may be necessary. The use of SEMIKRON products in life support appliances and systems is subject to prior specification and written approval by SEMIKRON. We therefore strongly recommend prior consultation of our personal.