

## Standard Rectifier Module

|                           |
|---------------------------|
| <b>3~<br/>Rectifier</b>   |
| $V_{RRM} = 1600\text{ V}$ |
| $I_{DAV} = 125\text{ A}$  |
| $I_{FSM} = 1000\text{ A}$ |

### 3~ Rectifier Bridge

Part number

VUO122-16N07

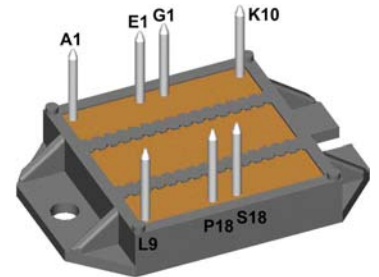

 E72873

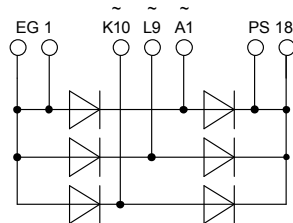

#### Features / Advantages:

- Package with DCB ceramic
- Improved temperature and power cycling
- Planar passivated chips
- Very low forward voltage drop
- Very low leakage current

#### Applications:

- Diode for main rectification
- For three phase bridge configurations
- Supplies for DC power equipment
- Input rectifiers for PWM inverter
- Battery DC power supplies
- Field supply for DC motors

#### Package: ECO-PAC2

- Industry standard outline
- RoHS compliant
- Soldering pins for PCB mounting
- Height: 9 mm
- Base plate: DCB ceramic
- Reduced weight
- Advanced power cycling

| Rectifier  |  |  |                              | Ratings                      |      |      |                   |
|------------|--|--|------------------------------|------------------------------|------|------|-------------------|
| Symbol     | Definition                                   | Conditions   |                              | min.                         | typ. | max. | Unit              |
| $V_{RSM}$  | max. non-repetitive reverse blocking voltage |  |                              |                              |      | 1700 | V                 |
| $V_{RRM}$  | max. repetitive reverse blocking voltage     |  |                              |                              |      | 1600 | V                 |
| $I_R$      | reverse current                              | $V_R = 1600$ V   | $T_{VJ} = 25^\circ\text{C}$  |                              |      | 100  | $\mu\text{A}$     |
|            |  | $V_R = 1600$ V   | $T_{VJ} = 150^\circ\text{C}$ |                              |      | 2    | mA                |
| $V_F$      | forward voltage drop                         | $I_F = 50$ A   | $T_{VJ} = 25^\circ\text{C}$  |                              |      | 1.13 | V                 |
|            |  |  |                              |                              |      | 1.47 | V                 |
|            |  | $I_F = 150$ A  | $T_{VJ} = 125^\circ\text{C}$ |                              |      | 1.05 | V                 |
|            |  |  |                              |                              |      | 1.49 | V                 |
| $I_{DAV}$  | bridge output current                        | $T_C = 115^\circ\text{C}$<br>rectangular $d = \frac{1}{3}$ | $T_{VJ} = 150^\circ\text{C}$ |                              |      | 125  | A                 |
|            |  |  |                              |                              |      |      |                   |
| $V_{FO}$   | threshold voltage                            |  |                              | $T_{VJ} = 150^\circ\text{C}$ |      | 0.80 | V                 |
| $r_F$      | slope resistance                             |  |                              |                              |      |      | 4.6               |
| $R_{thJC}$ | thermal resistance junction to case          |  |                              |                              |      | 0.6  | K/W               |
| $R_{thCH}$ | thermal resistance case to heatsink          |  |                              |                              | 0.3  |      | K/W               |
| $P_{tot}$  | total power dissipation                      |  |                              | $T_C = 25^\circ\text{C}$     |      | 205  | W                 |
| $I_{FSM}$  | max. forward surge current                   | $t = 10$ ms; (50 Hz), sine                                 | $T_{VJ} = 45^\circ\text{C}$  |                              |      | 1.00 | kA                |
|            |  |  |                              |                              |      | 1.08 | kA                |
|            |  | $t = 8,3$ ms; (60 Hz), sine                                | $V_R = 0$ V                  | $T_{VJ} = 150^\circ\text{C}$ |      | 850  | A                 |
|            |  |  |                              | $T_{VJ} = 150^\circ\text{C}$ |      | 920  | A                 |
| $I^2t$     | value for fusing                             | $t = 10$ ms; (50 Hz), sine                                 | $T_{VJ} = 45^\circ\text{C}$  |                              |      | 5.00 | kA <sup>2</sup> s |
|            |  |  |                              |                              |      | 4.85 | kA <sup>2</sup> s |
|            |  | $t = 8,3$ ms; (60 Hz), sine                                | $V_R = 0$ V                  | $T_{VJ} = 150^\circ\text{C}$ |      | 3.62 | kA <sup>2</sup> s |
|            |  |  |                              | $T_{VJ} = 150^\circ\text{C}$ |      | 3.52 | kA <sup>2</sup> s |
| $C_J$      | junction capacitance                         | $V_R = 400$ V; $f = 1$ MHz                                 | $T_{VJ} = 25^\circ\text{C}$  |                              | 35   |      | pF                |

| Package ECO-PAC2 |  | Ratings   |      |      |      |      |
|------------------|--|---|------|------|------|------|
| Symbol           | Definition   | Conditions  | min. | typ. | max. | Unit |
| $I_{RMS}$        | RMS current  | per terminal  |      |      | 100  | A    |
| $T_{stg}$        | storage temperature  |   | -40  |      | 125  | °C   |
| $T_{VJ}$         | virtual junction temperature                                 |   | -40  |      | 150  | °C   |
| <b>Weight</b>    |  |   |      | 24   |      | g    |
| $M_D$            | mounting torque  |   | 1.5  |      | 2    | Nm   |
| $d_{Spp/App}$    | creepage distance on surface   striking distance through air | terminal to terminal                                | 6.0  |      |      | mm   |
| $d_{Spb/Apb}$    |  | terminal to backside                                | 10.0 |      |      | mm   |
| $V_{ISOL}$       | isolation voltage  | t = 1 second  | 3000 |      |      | V    |
|                  |  | t = 1 minute<br>50/60 Hz, RMS; $I_{ISOL} \leq 1$ mA | 2500 |      |      | V    |

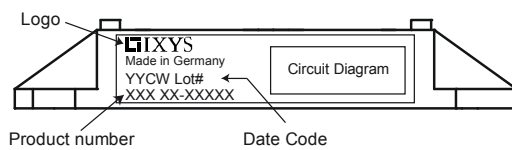

| Ordering | Part Number  | Marking on Product | Delivery Mode | Quantity | Code No. |
|----------|--------------|--------------------|---------------|----------|----------|
| Standard | VUO122-16NO7 | VUO122-16NO7       | Box           | 25       | 494453   |

### Equivalent Circuits for Simulation \* on die level $T_{VJ} = 150^\circ\text{C}$

| Symbol | Definition         | Value | Unit |
|--------|--------------------|-------|------|
| $V_0$  | threshold voltage  | 0.8   | V    |
| $R_0$  | slope resistance * | 3.4   | mΩ   |

Outlines ECO-PAC2

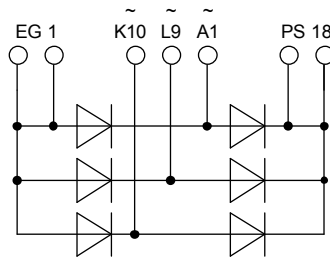
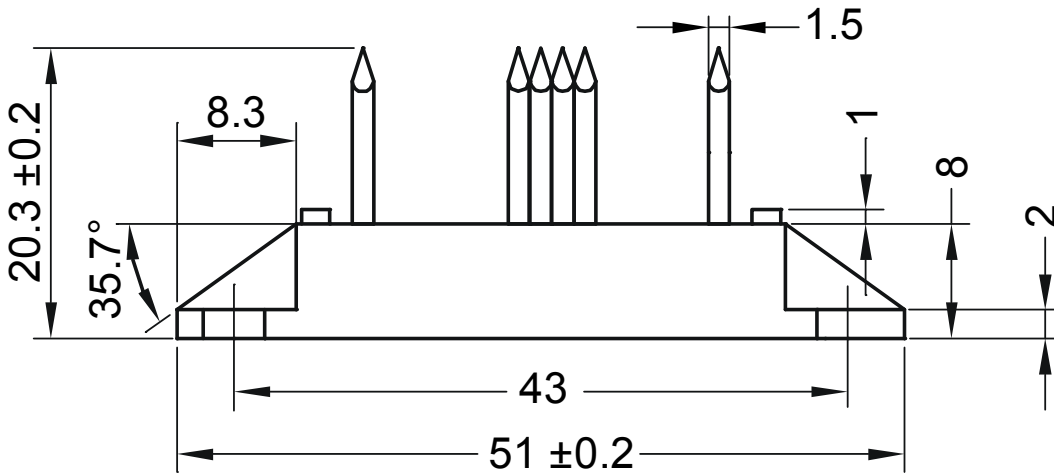
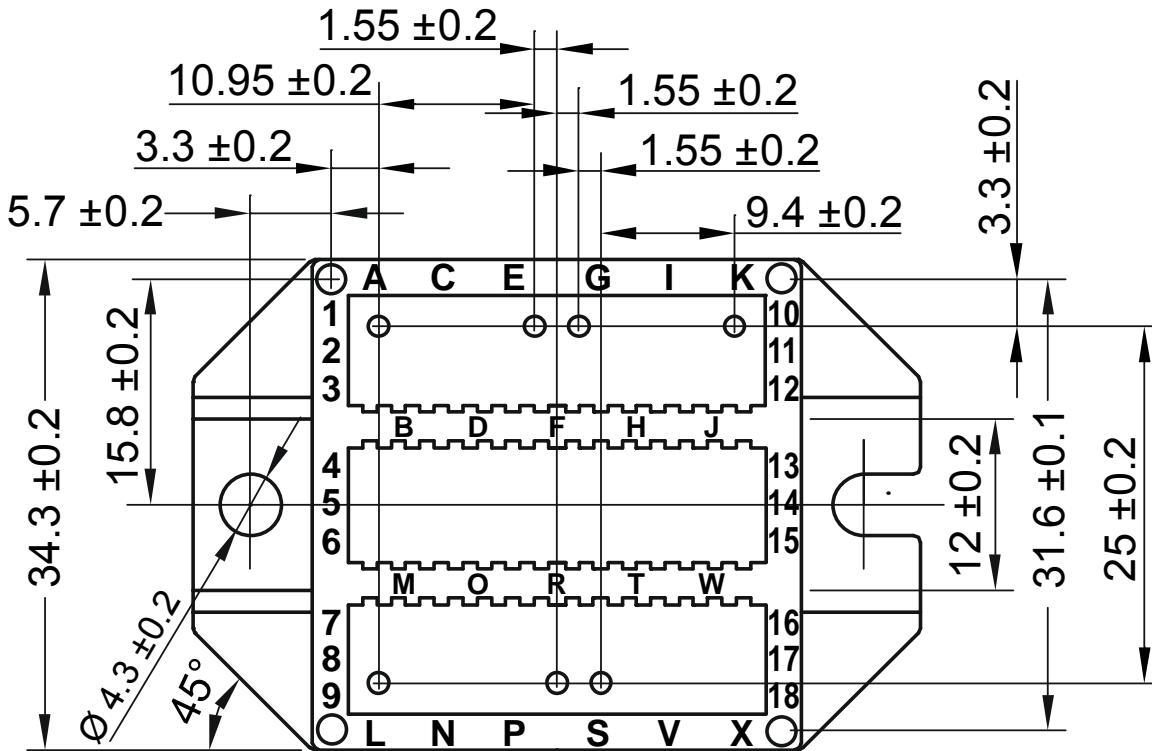

Rectifier

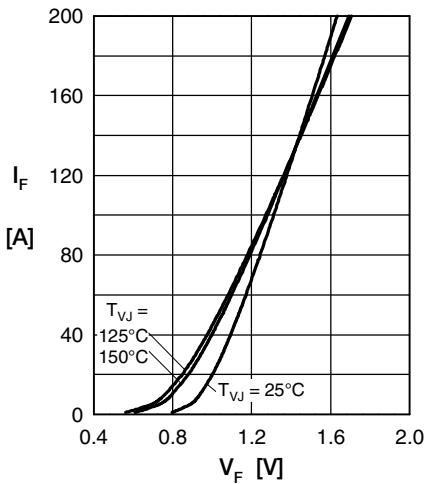

Fig. 1 Forward current vs. voltage drop per diode

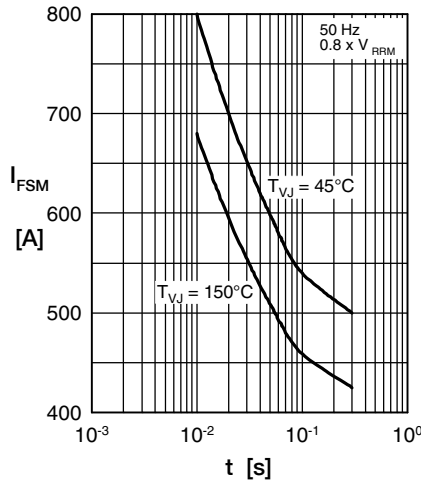

Fig. 2 Surge overload current vs. time per diode

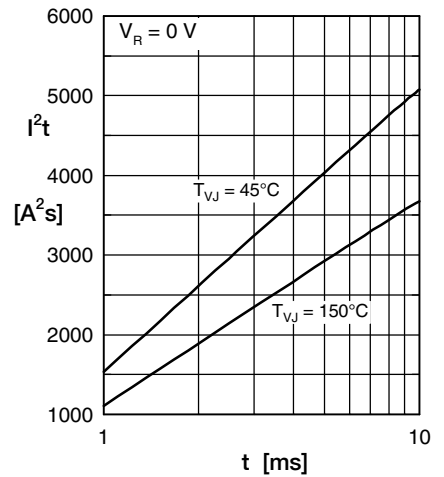

Fig. 3  $I^2t$  vs. time per diode

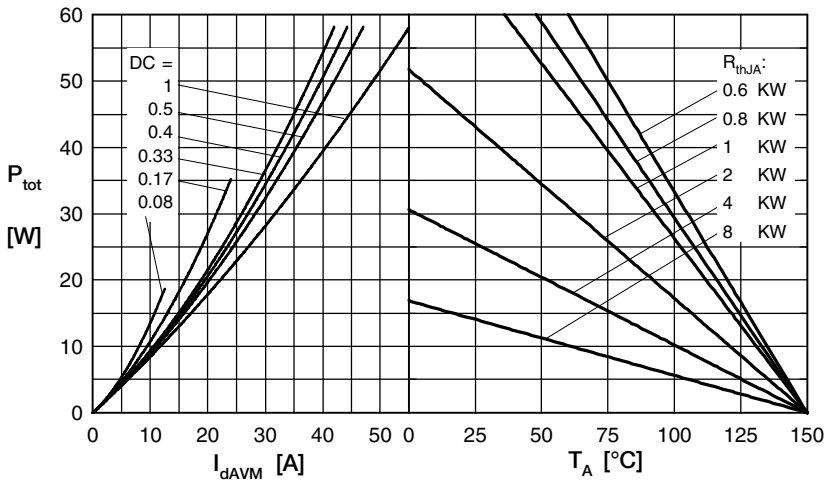

Fig. 4 Power dissipation vs. forward current and ambient temperature per diode

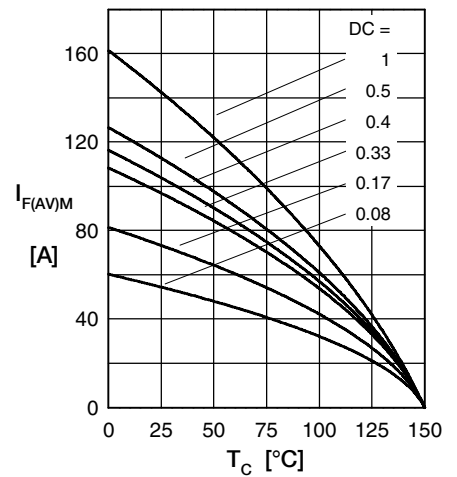

Fig. 5 Max. forward current vs. case temperature per diode

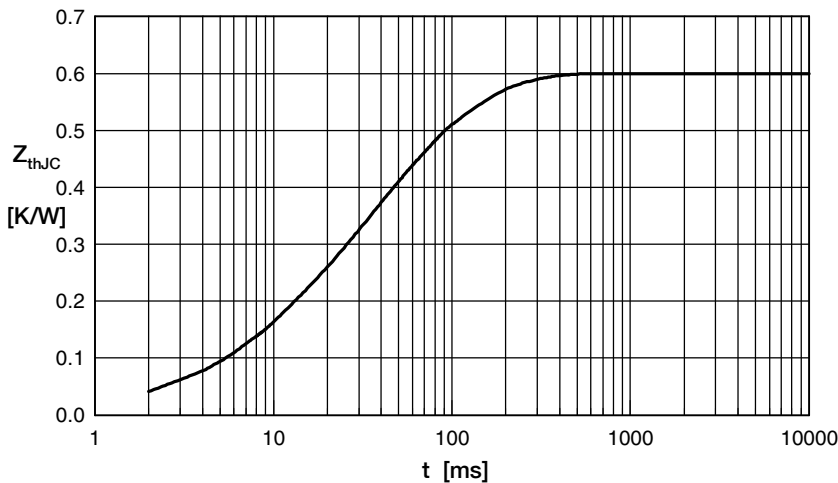

Fig. 6 Transient thermal impedance junction to case vs. time per diode

Constants for  $Z_{thJC}$  calculation:

| i | $R_{th}$ (K/W) | $t_i$ (s) |
|---|----------------|-----------|
| 1 | 0.08           | 0.012     |
| 2 | 0.04           | 0.007     |
| 3 | 0.29           | 0.036     |
| 4 | 0.19           | 0.102     |