

HiPerFRED

$$V_{RRM} = 1200 \text{ V}$$

$$I_{FAV} = 30 \text{ A}$$

$$t_{rr} = 40 \text{ ns}$$

High Performance Fast Recovery Diode
Low Loss and Soft Recovery
Single Diode

Part number

DSEP30-12AR

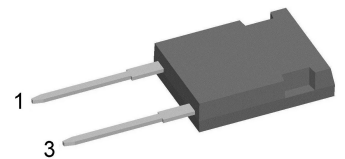

Backside: isolated

 E72873

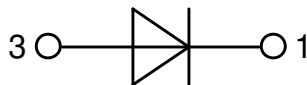

Features / Advantages:

- Planar passivated chips
- Very low leakage current
- Very short recovery time
- Improved thermal behaviour
- Very low I_{rm} -values
- Very soft recovery behaviour
- Avalanche voltage rated for reliable operation
- Soft reverse recovery for low EMI/RFI
- Low I_{rm} reduces:
 - Power dissipation within the diode
 - Turn-on loss in the commutating switch

Applications:

- Antiparallel diode for high frequency switching devices
- Antisaturation diode
- Snubber diode
- Free wheeling diode
- Rectifiers in switch mode power supplies (SMPS)
- Uninterruptible power supplies (UPS)

Package: ISOPLUS247

- Isolation Voltage: 3600 V~
- Industry standard outline
- RoHS compliant
- Epoxy meets UL 94V-0
- Soldering pins for PCB mounting
- Backside: DCB ceramic
- Reduced weight
- Advanced power cycling

Terms and Conditions of Usage

The data contained in this product data sheet is exclusively intended for technically trained staff. The user will have to evaluate the suitability of the product for the intended application and the completeness of the product data with respect to his application. The specifications of our components may not be considered as an assurance of component characteristics. The information in the valid application- and assembly notes must be considered. Should you require product information in excess of the data given in this product data sheet or which concerns the specific application of your product, please contact your local sales office.

Due to technical requirements our product may contain dangerous substances. For information on the types in question please contact your local sales office.

Should you intend to use the product in aviation, in health or life endangering or life support applications, please notify. For any such application we urgently recommend

- to perform joint risk and quality assessments;

- the conclusion of quality agreements;

- to establish joint measures of an ongoing product survey, and that we may make delivery dependent on the realization of any such measures.

Fast Diode				Ratings			
Symbol	Definition	Conditions	min.	typ.	max.	Unit	
V_{RSM}	max. non-repetitive reverse blocking voltage	$T_{VJ} = 25^{\circ}C$			1200	V	
V_{RRM}	max. repetitive reverse blocking voltage	$T_{VJ} = 25^{\circ}C$			1200	V	
I_R	reverse current, drain current	$V_R = 1200 V$	$T_{VJ} = 25^{\circ}C$		250	μA	
		$V_R = 1200 V$	$T_{VJ} = 150^{\circ}C$		1	mA	
V_F	forward voltage drop	$I_F = 30 A$	$T_{VJ} = 25^{\circ}C$		2.74	V	
		$I_F = 60 A$			3.27	V	
		$I_F = 30 A$	$T_{VJ} = 150^{\circ}C$		1.79	V	
		$I_F = 60 A$			2.30	V	
I_{FAV}	average forward current	$T_C = 105^{\circ}C$ rectangular $d = 0.5$	$T_{VJ} = 175^{\circ}C$		30	A	
V_{FO}	threshold voltage	} for power loss calculation only	$T_{VJ} = 175^{\circ}C$		1.12	V	
r_F	slope resistance				16	m Ω	
R_{thJC}	thermal resistance junction to case				1.1	K/W	
R_{thCH}	thermal resistance case to heatsink			0.25		K/W	
P_{tot}	total power dissipation		$T_C = 25^{\circ}C$		135	W	
I_{FSM}	max. forward surge current	$t = 10 ms; (50 Hz), sine; V_R = 0 V$	$T_{VJ} = 45^{\circ}C$		200	A	
C_J	junction capacitance	$V_R = 600 V$ $f = 1 MHz$	$T_{VJ} = 25^{\circ}C$		12	pF	
I_{RM}	max. reverse recovery current	} $I_F = 30 A; V_R = 600 V$ $-di_F / dt = 200 A/\mu s$	$T_{VJ} = 25^{\circ}C$		8.5	A	
			$T_{VJ} = 100^{\circ}C$		13	A	
t_{rr}	reverse recovery time		$T_{VJ} = 25^{\circ}C$		60	ns	
			$T_{VJ} = 100^{\circ}C$		170	ns	

Package ISOPLUS247		Ratings				
Symbol	Definition	Conditions	min.	typ.	max.	Unit
I_{RMS}	RMS current	per terminal			70	A
T_{VJ}	virtual junction temperature		-55		175	°C
T_{op}	operation temperature		-55		150	°C
T_{stg}	storage temperature		-55		150	°C
Weight				6		g
F_C	mounting force with clip		20		120	N
$d_{Spp/App}$	creepage distance on surface / striking distance through air	terminal to terminal	5.4			mm
$d_{Spb/Apb}$		terminal to backside	4.1			mm
V_{ISOL}	isolation voltage	t = 1 second	3600			V
		t = 1 minute	3000			V

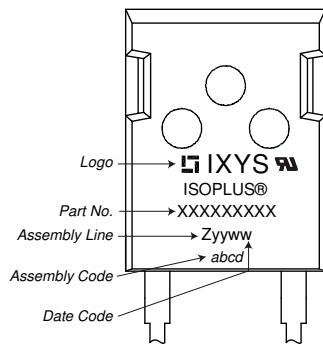
Product Marking

Ordering	Ordering Number	Marking on Product	Delivery Mode	Quantity	Code No.
Standard	DSEP30-12AR	DSEP30-12AR	Tube	30	481920

Similar Part	Package	Voltage class
DSEP30-12A	TO-247AD (2)	1200
DSEP29-12A	TO-220AC (2)	1200
DHG30I1200HA	TO-247AD (2)	1200
DSEP30-12CR	ISOPLUS247 (2)	1200
DSEP30-12B	TO-247AD (2)	1200

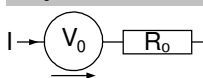
Equivalent Circuits for Simulation
** on die level*
 $T_{VJ} = 175\text{°C}$

Fast Diode

$V_{0\ max}$	threshold voltage	1.12	V
$R_{0\ max}$	slope resistance *	13.4	mΩ

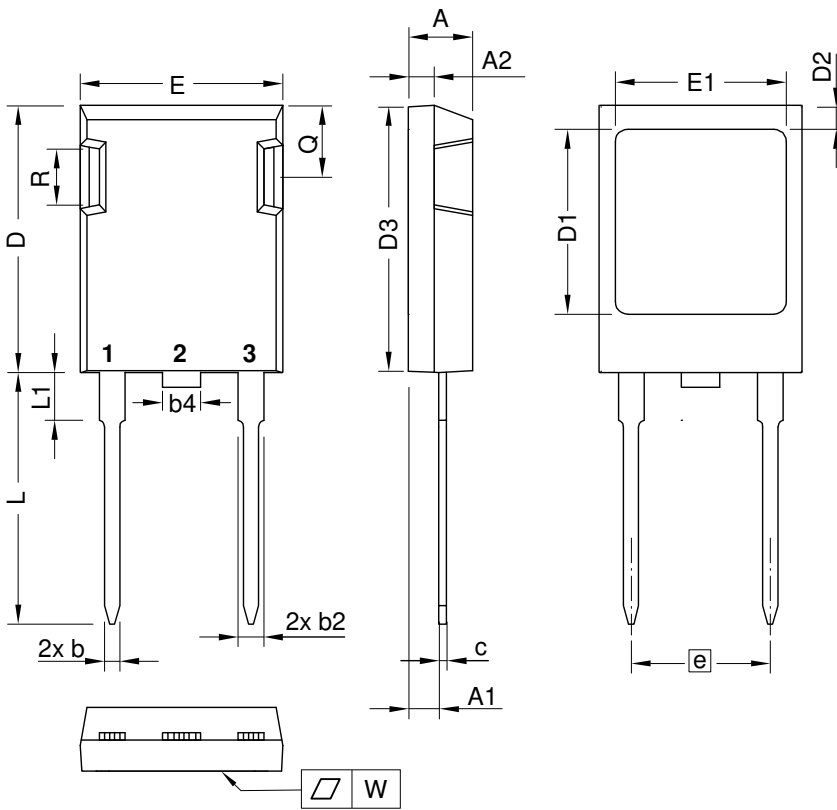
Outlines ISOPLUS247



Dim.	Millimeter		Inches	
	min	max	min	max
A	4.83	5.21	0.190	0.205
A1	2.29	2.54	0.090	0.100
A2	1.91	2.16	0.075	0.085
b	1.14	1.40	0.045	0.055
b2	1.91	2.20	0.075	0.087
b4	2.92	3.24	0.115	0.128
c	0.61	0.83	0.024	0.033
D	20.80	21.34	0.819	0.840
D1	15.75	16.26	0.620	0.640
D2	1.65	2.15	0.065	0.085
D3	20.30	20.70	0.799	0.815
E	15.75	16.13	0.620	0.635
E1	13.21	13.72	0.520	0.540
e	10.90 BSC		0.429 BSC	
L	19.81	20.60	0.780	0.811
L1	3.81	4.38	0.150	0.172
Q	5.59	6.20	0.220	0.244
R	4.25	5.50	0.167	0.217
W	-	0.10	-	0.004

Die konvexe Form des Substrates ist typ. < 0.04 mm über der Kunststoffoberfläche der Bauteilunterseite
 The convex bow of substrate is typ. < 0.04 mm over plastic surface level of device bottom side

Die Gehäuseabmessungen entsprechen dem Typ TO-247 AD gemäß JEDEC außer Schraubloch und L_{max} .
 This drawing will meet all dimensions requirement of JEDEC outline TO-247 AD except screw hole and except L_{max} .



Fast Diode

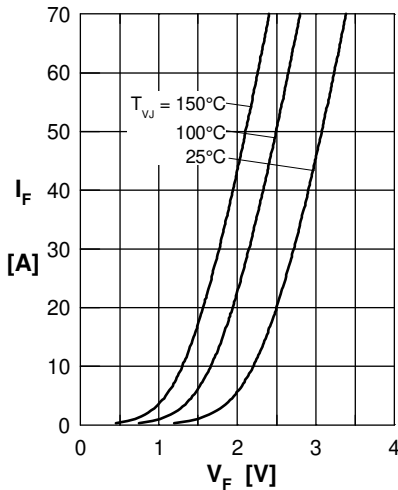

Fig. 1 Forward current I_F versus V_F

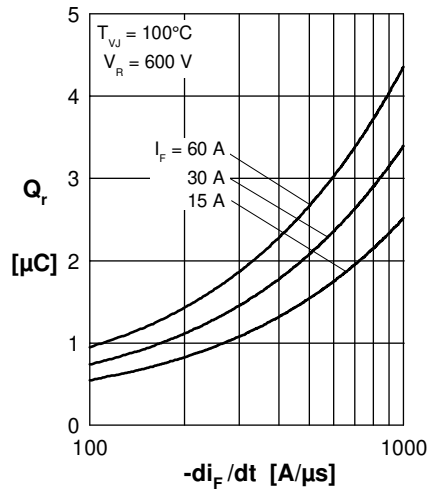

Fig. 2 Typ. reverse recov. charge Q_r versus $-di_F/dt$

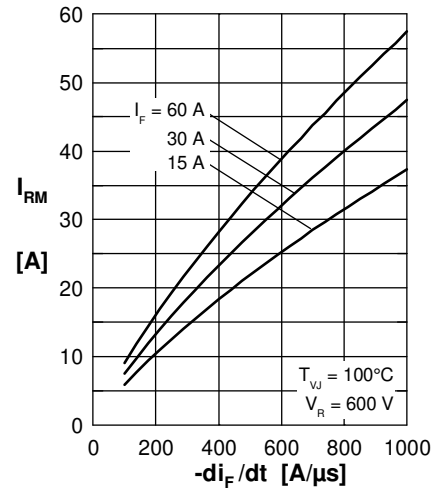

Fig. 3 Typ. peak reverse current I_{RM} versus $-di_F/dt$

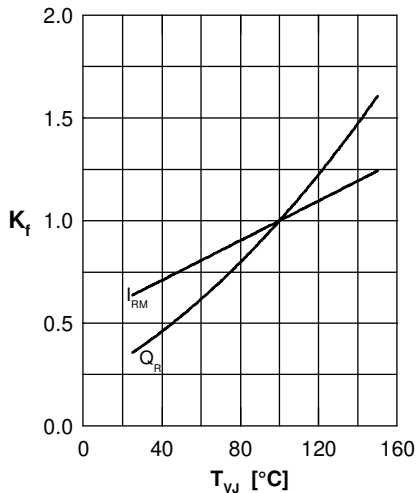

Fig. 4 Typ. dynamic parameters Q_r, I_{RM} versus T_{VJ}

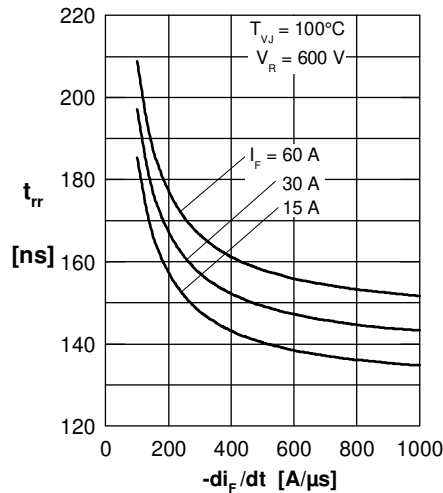

Fig. 5 Typ. recovery time t_{tr} versus $-di_F/dt$

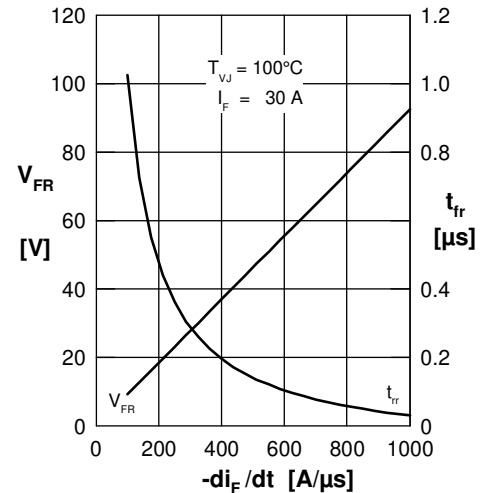

Fig. 6 Typ. peak forward voltage V_{FR} and t_{tr} versus di_F/dt

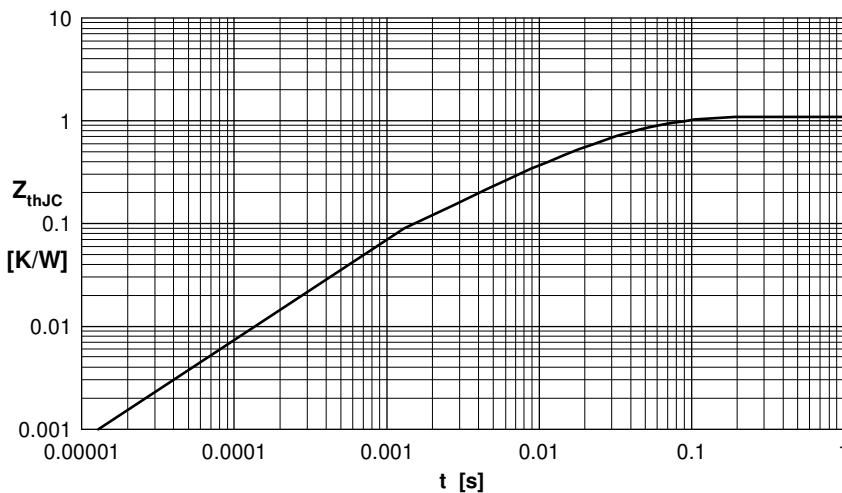

Fig. 7 Transient thermal impedance junction to case

Constants for Z_{thJC} calculation:

i	R_{thi} (K/W)	t_i (s)
1	0.030	0.0005
2	0.100	0.0050
3	0.360	0.0200
4	0.610	0.0500